

1xT26  $\eta=63\%$

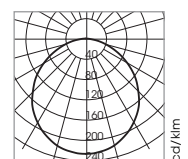



2xT26  $\eta=55\%$

Eckleuchte [IP 43] für Unterführungen, Gehäuse aus Aluminium, weiß thermolackiert. Reflektoreinsatz aus Aluminium, weiß thermolackiert, herausnehmbar. Kabelführung stirnseitig oder auf der Rückseite mit Stopfen M20, Anschlussklemme 5x4mm<sup>2</sup>. Abdeckung aus Acrylglas opal.

Luminaire [IP 43] for corner mounting, for subways, housing aluminium white thermocoated, removable reflector aluminium, white thermocoated. End or rear cable entry through M20 glands, terminal 5x4mm<sup>2</sup>. Acrylic diffuser opal.

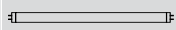
Luminaire [IP 43] à angle pour passages souterrains, boîtier en aluminium, thermolaqué blanc, réflecteur en aluminium, thermolaqué blanc, amovible. Entrée de câble M20 latérale ou à l'arrière avec presse étoupe, borne de raccordement 5x4mm<sup>2</sup>. Diffuseur en verre acrylique opale.

Art. No.		
1031WS-1367	1x36W T26	EVG
1031WS-2367	2x36W T26	EVG

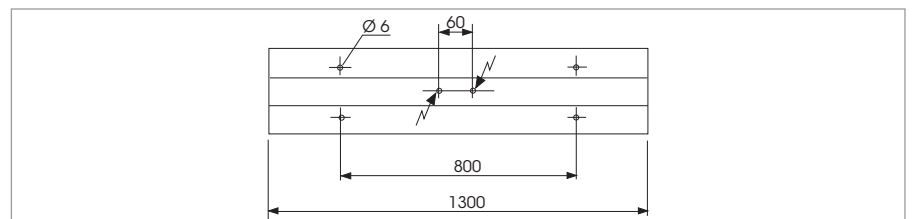

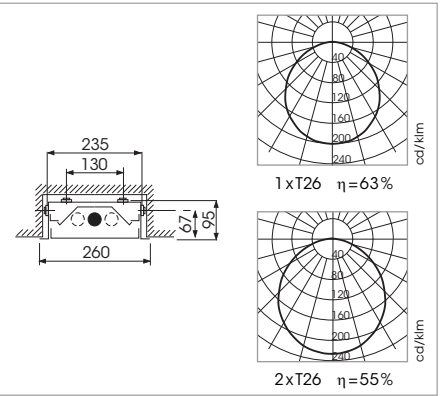

Einbauleuchte [IP 43] für Unterführungen, Gehäuse aus Aluminium, weiß thermolackiert, Reflektoreinsatz aus Aluminium, weiß thermolackiert, herausnehmbar. Kabeleinführung stirnseitig oder auf der Rückseite mit Stopfen M20, Anschlussklemme 5x4mm<sup>2</sup>. Abdeckung aus Acrylglas opal.

Recessed mounted luminaire [IP 43], for subways, housing aluminium white thermocoated, removable reflector aluminium, white thermocoated. End or rear cable entry through M20 glands, terminal 5x4mm<sup>2</sup>. Acrylic diffuser opal.

Luminaire à encastrer [IP 43] pour passages souterrains, boîtier en aluminium, thermolaqué blanc, réflecteur en aluminium, thermolaqué blanc, amovible. Entrée de câble M20 latérale ou à l'arrière avec presse-étoupe, borne de raccordement 5x4mm<sup>2</sup>. Diffuseur en verre acrylique opale.

Art. No.		
1032WS-1367	1x36W T26	EVG
1032WS-2367	2x36W T26	EVG

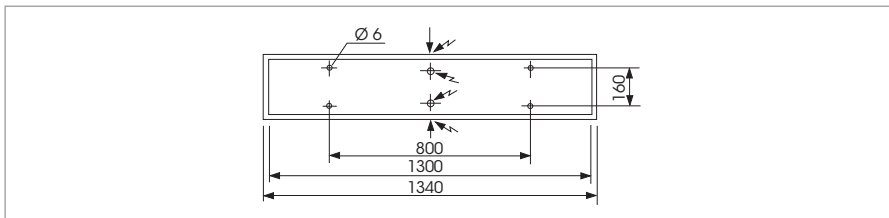

## ERSATZ-ZUBEHÖR ACCESSORIES ACCESSOIRES

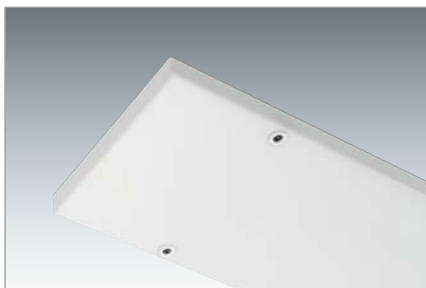

Ersatzglas-Abdeckung aus Acrylglas, opal, inkl. Schrauben.

Spare glass, opal acrylic, with screws.

Verre de rechange, acrylique, opale, avec vis.

Ersatzglas-Abdeckung aus Polycarbonat, opal, inkl. Schrauben.

Spare glass, opal polycarbonate, with screws.

Verre de rechange, polycarbonate, opale, avec vis.

Art. No.	
1031WS-G79	1x36W T26

Art. No.	
1031PW-G79	1x36W T26