

ANBAU- UND PENDELLEUCHTEN

Surface mounted and
pendant luminaires
*Luminaires apparent
et suspendu*

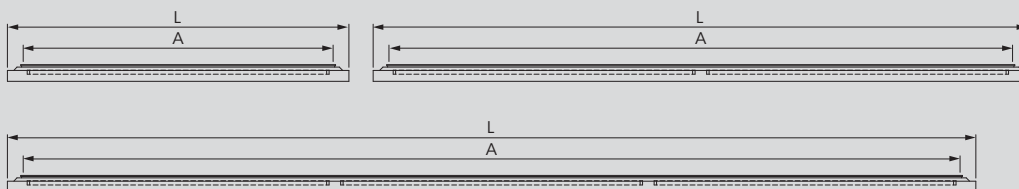

5



A ... Seilabhängung variabel
 A ... variable for cable suspension
 A ... pour fixation à fils variable

$A_{\max} = L - 120\text{mm}$

A ... für Deckenmontage/Pendelaufhängung
 A ... for ceiling mounting/pendant suspension
 A ... pour fixation au plafond/suspension pendulaire

$A_{\max} = L - 200\text{mm}$

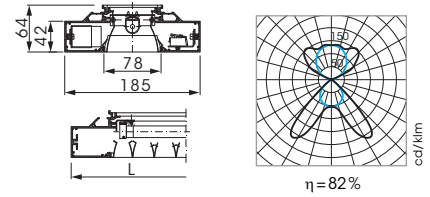

Direkt/indirekt strahlende Spiegelraster-Anbau- und Pendelleuchte, Alu-Profil farblos eloxiert, in 1-, 2- und 3-längiger Ausführung.
Spiegelraster Aluminium hochglanz, rundum entblendet.

Zubehör:
bitte separat bestellen [Seite 5.9-5.10]

Surface mounted or pendant direct/indirect luminaire with mirror louvre, aluminium profile natural anodized, available in single-, dual- and triple-length. Mirror louvre, highly polished aluminium, glare free.

Accessories:
please order separately [page 5.9-5.10]

Luminaire apparent et suspendu à écran miroité pour éclairage direct/indirect, profilé en aluminium anodisé nature, en version mono, duo et triple longueurs.

Ecran en aluminium miroité poli brillant, non-éblouissant de toutes les directions.

Accessoires:
veuillez s.v.p. commander séparément [page 5.9-5.10]

Art. No.		L [mm]
1-längig single-length mono longueur		
4010HB-1287	1 x 1 x 28 W T5	1300
4010HB-1547	1 x 1 x 54 W T5	1300
4010HB-1357	1 x 1 x 35 W T5	1600
4010HB-1807	1 x 1 x 80 W T5	1600

Art. No.		L [mm]
2-längig dual-length duo longueur		
4020HB-2287	2 x 1 x 28 W T5	2493
4020HB-2547	2 x 1 x 54 W T5	2493
4020HB-2357	2 x 1 x 35 W T5	3093
4020HB-2807	2 x 1 x 80 W T5	3093

Art. No.		L [mm]
3-längig triple-length triple longueur		
4030HB-3287	3 x 1 x 28 W T5	3686
4030HB-3547	3 x 1 x 54 W T5	3686
4030HB-3357	3 x 1 x 35 W T5	4586
4030HB-3807	3 x 1 x 80 W T5	4586

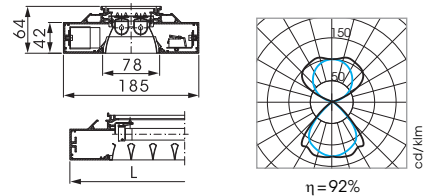

Direkt/indirekt strahlende Spiegelraster-Anbau- und Pendelleuchte, Alu-Profil farblos eloxiert, in 1-, 2- und 3-längiger Ausführung.
Spiegelraster Aluminium hochglanz, rundum entblendet.

Zubehör:
bitte separat bestellen [Seite 5.9-5.10]

Surface mounted or pendant direct/indirect luminaire with mirror louvre, aluminium profile natural anodized, available in single-, dual- and triple-length. Mirror louvre, highly polished aluminium, glare free.

Accessories:
please order separately [page 5.9-5.10]

Luminaire apparent et suspendu à écran miroité pour éclairage direct/indirect, profilé en aluminium anodisé nature, en version mono, duo et triple longueurs.

Ecran en aluminium miroité poli brillant, non-éblouissant de toutes les directions.

Accessoires:
veuillez s.v.p. commander séparément [page 5.9-5.10]

Art. No.		L [mm]
1-längig single-length mono longueur		
4010HB-2287	1 x 2 x 28 W T5	1300
4010HB-2547	1 x 2 x 54 W T5	1300
4010HB-2357	1 x 2 x 35 W T5	1600
4010HB-2807	1 x 2 x 80 W T5	1600

Art. No.		L [mm]
2-längig dual-length duo longueur		
4020HB-4287	2 x 2 x 28 W T5	2493
4020HB-4547	2 x 2 x 54 W T5	2493
4020HB-4357	2 x 2 x 35 W T5	3093
4020HB-4807	2 x 2 x 80 W T5	3093

Art. No.		L [mm]
3-längig triple-length triple longueur		
4030HB-6287	3 x 2 x 28 W T5	3686
4030HB-6547	3 x 2 x 54 W T5	3686
4030HB-6357	3 x 2 x 35 W T5	4586
4030HB-6807	3 x 2 x 80 W T5	4586

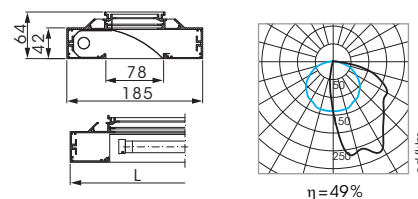
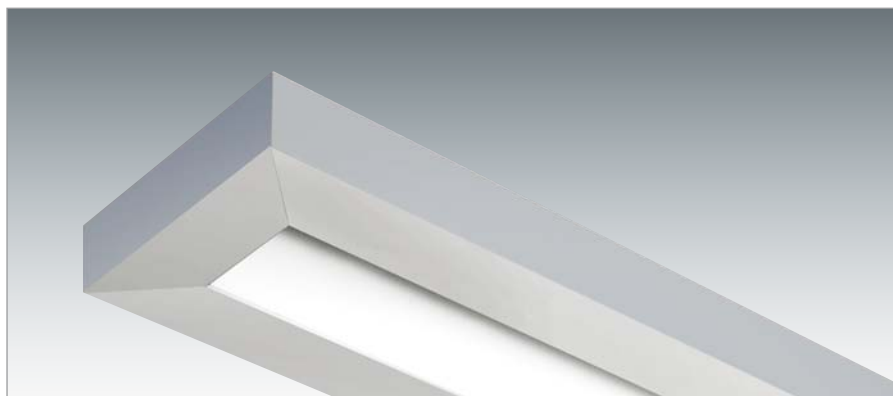

Asymmetrisch strahlende Anbau- und Pendelleuchte, Alu-Profil farblos eloxiert, in 1-, 2- und 3-längiger Ausführung.
Reflektor asymmetrisch, Aluminium matt.

Asymmetrically illuminating surface mounted or pendant luminaire, aluminium profile natural anodized, available in single-, dual- and triple-length.
Asymmetrical reflector, aluminium matt.

Luminaire apparent et suspendu pour éclairage asymétrique, profilé en aluminium anodisé nature, en version mono, duo et triple longueurs.
Réflecteur asymétrique, en aluminium mat.

Zubehör:
bitte separat bestellen [Seite 5.9-5.10]

Accessories:
please order separately [page 5.9-5.10]

Accessoires:
veuillez s.v.p. commander séparément [page 5.9-5.10]

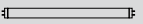
Art. No.		L [mm]
1-längig single-length mono longueur		
4060AS-1287	1 x 1 x 28W T5	1300
4060AS-1547	1 x 1 x 54W T5	1300
4060AS-1357	1 x 1 x 35W T5	1600
4060AS-1807	1 x 1 x 80W T5	1600

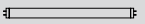
Art. No.		L [mm]
2-längig dual-length duo longueur		
4070AS-2287	2 x 1 x 28W T5	2493
4070AS-2547	2 x 1 x 54W T5	2493
4070AS-2357	2 x 1 x 35W T5	3093
4070AS-2807	2 x 1 x 80W T5	3093

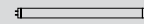
Art. No.		L [mm]
3-längig triple-length triple longueur		
4080AS-3287	3 x 1 x 28W T5	3686
4080AS-3547	3 x 1 x 54W T5	3686
4080AS-3357	3 x 1 x 35W T5	4586
4080AS-3807	3 x 1 x 80W T5	4586

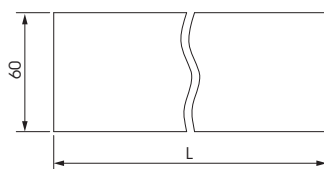
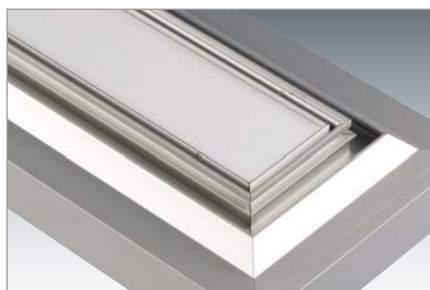

Blechabdeckung weiß für reine Direktstrahlung.

White cover plate for direct illumination.

Art. No.		L [mm]
4010-C19	28W/54W T5	1175
4010-C29	35W/80W T5	1475

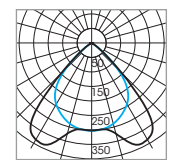

1 x T5 η=62%

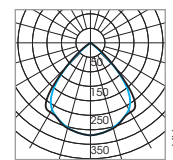

2 x T5 η=54%

Cache en tôle blanche pour un rayonnement direct.

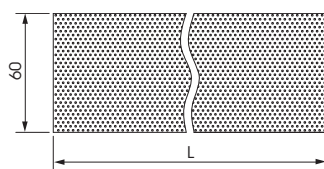

Lochblechabdeckung weiß für die Blendungsbegrenzung des Indirekt-Anteiles.

White perforated cover plate for glare reduction of the indirect section.

Art. No.		L [mm]
4010-C39	28W/54W T5	1175
4010-C49	35W/80W T5	1475

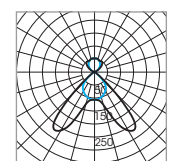

1 x T5 η=50%

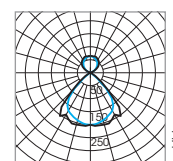

2 x T5 η=55%

Cache en tôle perforée blanche pour limiter l'éblouissement de la partie indirecte.

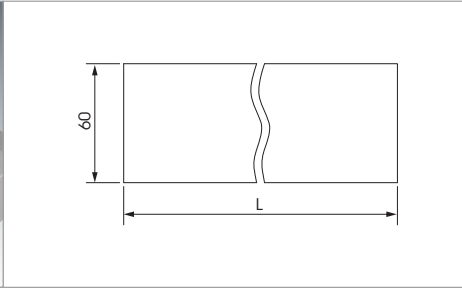

Acrylglasabdeckung opal für die Blendungsbegrenzung des Indirekt-Anteiles.

Opal acrylic glass cover for glare reduction of the indirect section.

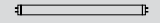
Art. No.		L [mm]
4010-G19	28 W/54 W T5	1172
4010-G29	35 W/80 W T5	1472

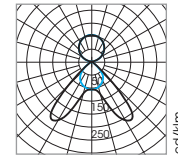

1xT5 $\eta=65\%$

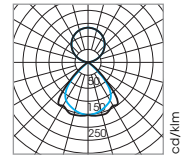

2xT5 $\eta=76\%$

Cache en verre acrylique opale pour limiter l'éblouissement de la partie indirecte.

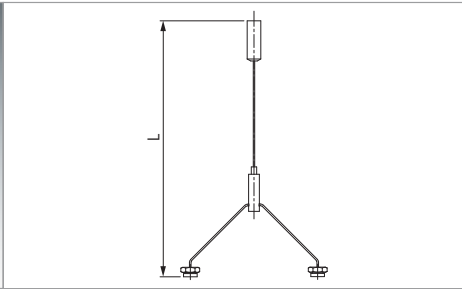
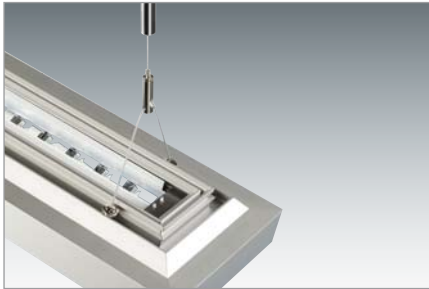

Dreipunkt-Seilauflhängung. 2 Stück für 1-längige Leuchte, mindestens 2 Stück für 2-längige Leuchte, mindestens 3 Stück für 3-längige Leuchte.

Three-point cable suspension. 2 units for single-length luminaires, minimum of 2 units for double-length luminaires, minimum of 3 units for triple-length luminaires.

Art. No.		L [mm]
4011		max. 2000

Câble de suspension à trois points. 2 pièces pour luminaires mono longueur, minimum 2 pièces pour luminaires duo longueur, minimum 3 pièces pour luminaires triple longueur.

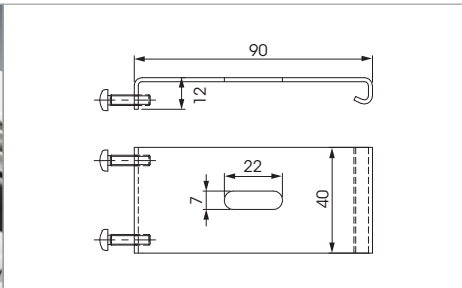

Deckenhalterung. 2 Stück für 1-längige Leuchte, mindestens 2 Stück für 2-längige Leuchte, mindestens 3 Stück für 3-längige Leuchte.

Ceiling mounting bracket. 2 units for single-length luminaires, minimum of 2 units for double-length luminaires, minimum of 3 units for triple-length luminaires.

Art. No.	
4014	nur mit Blechabdeckung 0-4010-... zu verwenden
	for use only with 0-4010 plate cover
	seulement à utiliser avec la tôle blanche 0-4010-...

Support de fixation au plafond. 2 pièces pour luminaires mono longueur, minimum 2 pièces pour luminaires duo longueur, minimum 3 pièces pour luminaires triple longueur.

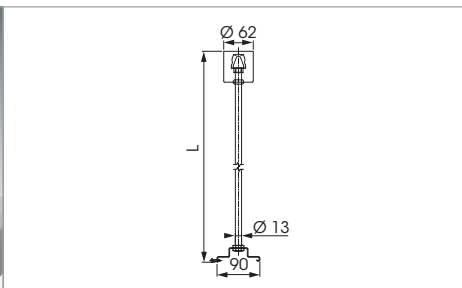

Rohrpendel. 2 Stück für 1-längige Leuchte, mindestens 2 Stück für 2-längige Leuchte, mindestens 3 Stück für 3-längige Leuchte.

Pendant tubing. 2 units for single-length luminaires, minimum of 2 units for double-length luminaires, minimum of 3 units for triple-length luminaires.

Art. No.		L [mm]
4015		max. 500

Tube pendulaire. 2 pièces pour luminaires mono longueur, minimum 2 pièces pour luminaires duo longueur, minimum 3 pièces pour luminaires triple longueur.

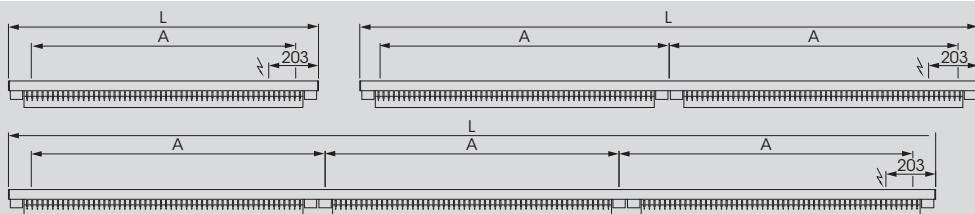

A ... Befestigungsabstand für Deckenmontage
Seilaufhängung und Befestigungsflansch
variabel

A ... Distance for ceiling mounting
variable for cable suspension and flange fitting

A ... Distance pour fixation au plafond
variable pour suspension à fils et bride de
fixation

ARKUS DI / DE

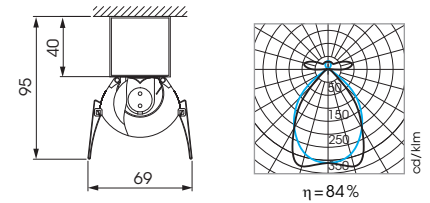
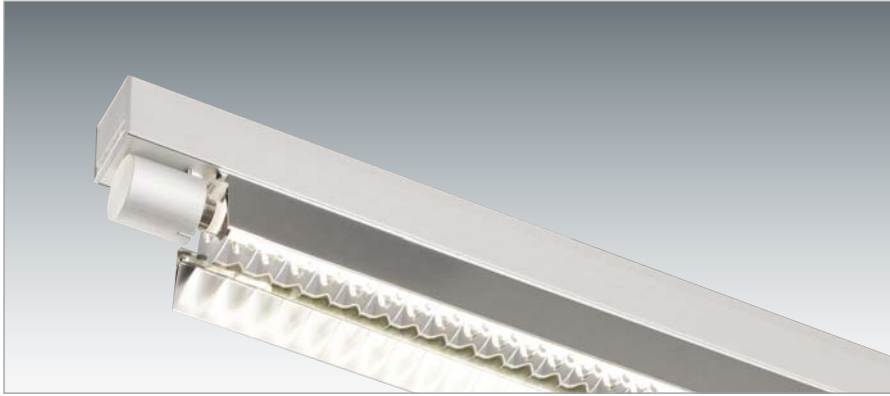

Raster-Anbau- und Pendelleuchte, Profil 40x40mm und Fassungskaschierung Aluminium farblos eloxiert, in 1-, 2- und 3-längiger Ausführung. Die 2- und 3-längigen Ausführungen enthalten eine Durchgangsverdrahtung 5x1,5mm². Ringlamellenraster Kunststoff, silber Alu-bedampft, Längsreflektoren Aluminium mattglanz, direkt/indirekt strahlend.

Surface mounted or pendant luminaire, with louvre, profile and lampholder aluminium natural anodized, available in single-, dual- and triple-length. The dual- and triple-length luminaires are equipped with a pre-assembled wiring 5x1,5mm². Lateral circular blades of louvre aluminised plastic, silver, longitudinal reflectors aluminium bright matt, illumination direct/indirect.

Luminaire apparent et suspendu avec écran, profilé 40x40mm et cache-douille en aluminium anodisé nature, en version mono, duo et triple longueurs. Les versions duo et triple longueur sont préalablement câblées 5x1,5mm². Ecran à lamelles circulaires en matière plastique, métallisé en l'aluminium, argenté, réflecteurs longitudinaux aluminium brillant mat, éclairage direct/indirect.

Art. No.	⌀	A [mm]	L [mm]
1-längig single-length mono longueur			
4600DI-1287	1 x 1 x 28W T5	1000	1266
4600DI-1547	1 x 1 x 54W T5	1000	1266
4600DI-1357	1 x 1 x 35W T5	1300	1566
4600DI-1807	1 x 1 x 80W T5	1300	1566

Art. No.	⌀	A [mm]	L [mm]
2-längig dual-length duo longueur			
4620DI-2287	2 x 1 x 28W T5	1180	2526
4620DI-2547	2 x 1 x 54W T5	1180	2526
4620DI-2357	2 x 1 x 35W T5	1480	3126
4620DI-2807	2 x 1 x 80W T5	1480	3126

Art. No.	⌀	A [mm]	L [mm]
3-längig triple-length triple longueur			
4630DI-3287	3 x 1 x 28W T5	1200	3786
4630DI-3547	3 x 1 x 54W T5	1200	3786
4630DI-3357	3 x 1 x 35W T5	1500	4686
4630DI-3807	3 x 1 x 80W T5	1500	4686

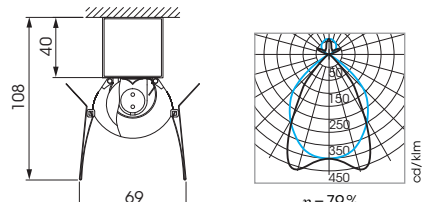
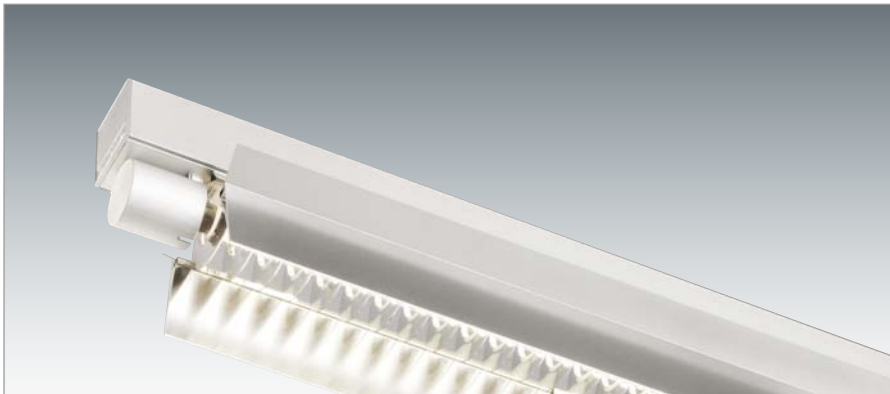

Raster-Anbau- und Pendelleuchte, Profil 40x40mm und Fassungskaschierung Aluminium farblos eloxiert, in 1-, 2- und 3-längiger Ausführung. Die 2- und 3-längigen Ausführungen enthalten eine Durchgangsverdrahtung 5x1,5mm². Ringlamellenraster Kunststoff, silber Alu-bedampft, Längsreflektoren Aluminium mattglanz, direkt/indirekt strahlend mit teilweiser Entblendung.

Surface mounted or pendant luminaire, with louvre, profile and lampholder aluminium natural anodized, available in single-, dual- and triple-length. The dual- and triple-length luminaires are equipped with a pre-assembled wiring 5x1,5mm². Lateral circular blades of louvre aluminised plastic, silver, longitudinal reflectors aluminium bright matt, illumination direct/indirect with limited dazzling.

Luminaire apparent et suspendu avec écran, profilé 40x40mm et cache-douille en aluminium anodisé nature, en version mono, duo et triple longueurs. Les versions duo et triple longueur sont préalablement câblées 5x1,5mm². Ecran à lamelles circulaires en matière plastique, métallisé en l'aluminium, argenté, réflecteurs longitudinaux aluminium brillant mat, éclairage direct/indirect avec éblouissement limité.

Art. No.	⌀	A [mm]	L [mm]
1-längig single-length mono longueur			
4600DE-1287	1 x 1 x 28W T5	1000	1266
4600DE-1547	1 x 1 x 54W T5	1000	1266
4600DE-1357	1 x 1 x 35W T5	1300	1566
4600DE-1807	1 x 1 x 80W T5	1300	1566

Art. No.	⌀	A [mm]	L [mm]
2-längig dual-length duo longueur			
4620DE-2287	2 x 1 x 28W T5	1180	2526
4620DE-2547	2 x 1 x 54W T5	1180	2526
4620DE-2357	2 x 1 x 35W T5	1480	3126
4620DE-2807	2 x 1 x 80W T5	1480	3126

Art. No.	⌀	A [mm]	L [mm]
3-längig triple-length triple longueur			
4630DE-3287	3 x 1 x 28W T5	1200	3786
4630DE-3547	3 x 1 x 54W T5	1200	3786
4630DE-3357	3 x 1 x 35W T5	1500	4686
4630DE-3807	3 x 1 x 80W T5	1500	4686

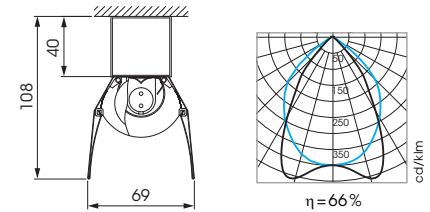
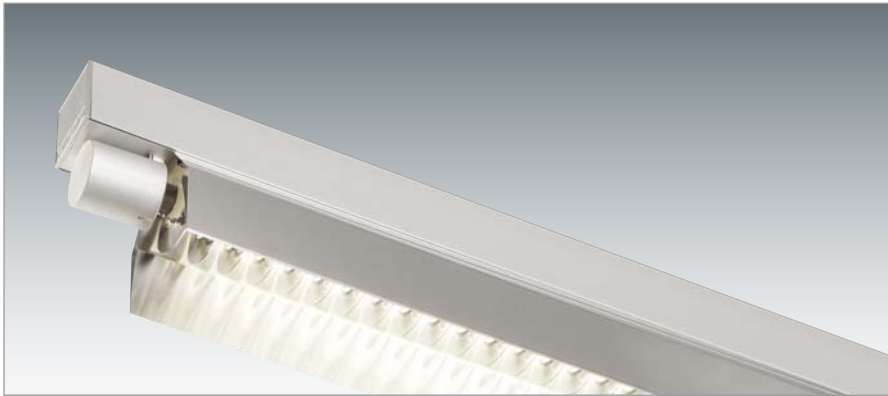

Raster-Anbau- und Pendelleuchte, Profil 40x40mm und Fassungskaschierung Aluminium farblos eloxiert, in 1-, 2- und 3-längiger Ausführung. Die 2- und 3-längigen Ausführungen enthalten eine Durchgangsverdrahtung 5x1,5mm². Ringlamellenraster Kunststoff, silber Alu-bedampft, Längsreflektoren Aluminium mattglanz, direkt strahlend.

Surface mounted or pendant luminaire, with louvre, profile and lampholder aluminium natural anodized, available in single-, dual- and triple-length. The dual- and triple-length luminaires are equipped with a pre-assembled wiring 5x1,5mm². Lateral strips of louvre aluminised plastic, silver, longitudinal reflectors aluminium bright matt, illumination direct.

Luminaire apparent et suspendu avec écran, profilé 40x40mm et cache-douille en aluminium anodisé nature, en version mono, duo et triple longueurs. Les versions duo et triple longueur sont préalablement câblée 5x1,5mm². Ecran à lamelles circulaires en matière plastique, métallisé en l'aluminium, argenté, réflecteurs longitudinaux aluminium brillant mat, éclairage direct.

Art. No.	⊓	A [mm]	L [mm]
1-längig single-length mono longueur			
4600DD-1287	1x1x28W T5	1000	1266
4600DD-1547	1x1x54W T5	1000	1266
4600DD-1357	1x1x35W T5	1300	1566
4600DD-1807	1x1x80W T5	1300	1566

Art. No.	⊓	A [mm]	L [mm]
2-längig dual-length duo longueur			
4620DD-2287	2x1x28W T5	1180	2526
4620DD-2547	2x1x54W T5	1180	2526
4620DD-2357	2x1x35W T5	1480	3126
4620DD-2807	2x1x80W T5	1480	3126

Art. No.	⊓	A [mm]	L [mm]
3-längig triple-length triple longueur			
4630DD-3287	3x1x28W T5	1200	3786
4630DD-3547	3x1x54W T5	1200	3786
4630DD-3357	3x1x35W T5	1500	4686
4630DD-3807	3x1x80W T5	1500	4686

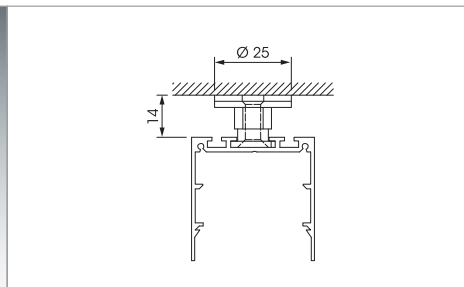

Befestigungsflansch für die Montage der Leuchten an die Decke mit einem Abstand von 14mm [pro Leuchte 2 Stück bestellen].

Flange fitting for ceiling mounting at a distance of 14mm [2 pieces per luminaire].

Art. No.
4512

Bride de fixation pour le montage au plafond avec une distance de 14mm [à commander 2 pièces par luminaire].

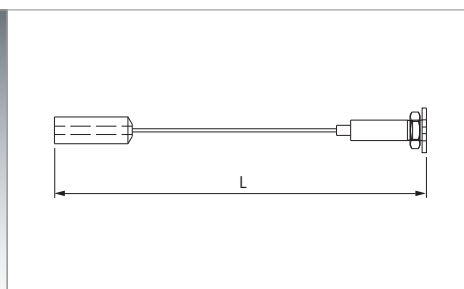
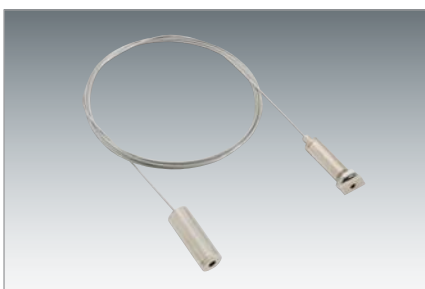

Stahlseilabhängung.
Bestellmenge:
• 2 Stück für 1-längige Leuchten.
• mind. 2 Stück für 2-längige Leuchten.
• mind. 3 Stück für 3-längige Leuchten.

Suspension wire.
Order quantities:
• 2 units for single-length luminaires.
• minimum of 2 units for double-length luminaires.
• minimum of 3 units for triple-length luminaires.

Art. No.	L [mm]
4511	max. 2000

Suspension à câble d'acier.
Quantités à commander:
• 2 pièces pour luminaires mono.
• minimum 2 pièces pour luminaires duo.
• minimum 3 pièces pour luminaires triple.

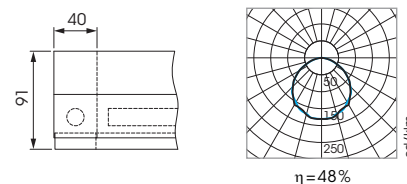

Anbau- und Pendelleuchte, Alu-Profil 40x40mm farblos eloxiert. Eingelegtes klares Acrylglas, einseitig matt.
Etwaige Stahlseilabhängungen bzw. Deckenbefestigungsflansche bitte separat bestellen.

Suspended and surface mounted luminaire, aluminium profile 40x40mm natural anodized. Clear acrylic laid-in diffuser, matt on one side. Please order any relevant steel wire suspensions resp. ceiling flange fitting separately.

Luminaire apparent et suspendu, profilé en aluminium 40x40mm, anodisé nature. Diffuseur intérieur en verre acrylique clair, un face mat. Veuillez s.v.p commander séparément des suspensions en câble acier resp. les brides de fixation aux plafonds.

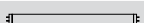
Art. No.			
4700GS-4147	4x14WT5		

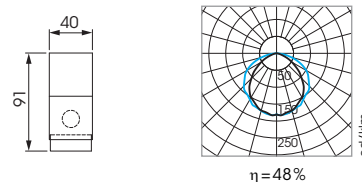
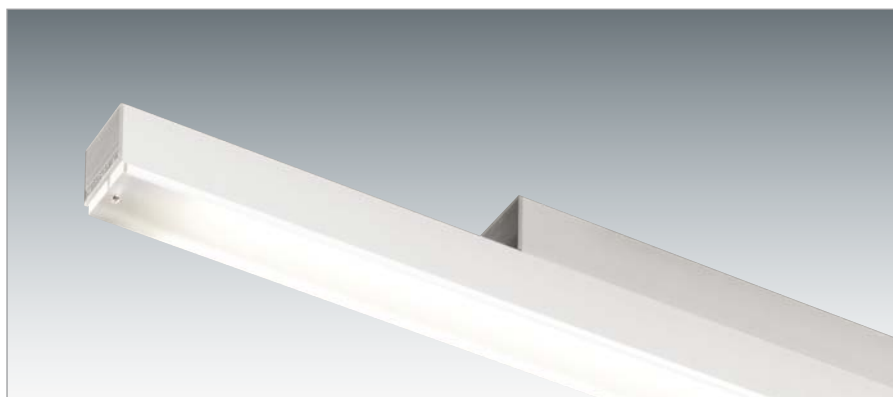
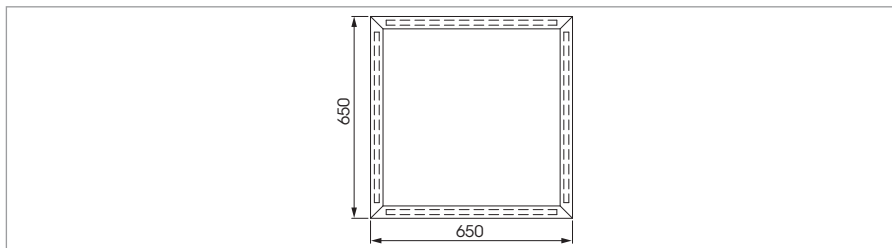

Anbau- und Pendelleuchte, Alu-Profil 40x40mm farblos eloxiert. Eingelegtes klares Acrylglas, einseitig matt.
Etwaige Stahlseilabhängungen bzw. Deckenbefestigungsflansche bitte separat bestellen.

Suspended and surface mounted luminaire, aluminium profile 40x40mm natural anodized. Clear acrylic laid-in diffuser, matt on one side. Please order any relevant steel wire suspensions resp. ceiling flange fitting separately.

Luminaire apparent et suspendu, profilé en aluminium 40x40mm, anodisé nature. Diffuseur intérieur en verre acrylique clair, un face mat. Veuillez s.v.p commander séparément des suspensions en câble acier resp. des brides de fixation aux plafonds.

Art. No.		A [mm]	L [mm]
4710GS-1217	1x21WT5	400	931
4710GS-1287	1x28WT5	400	1231

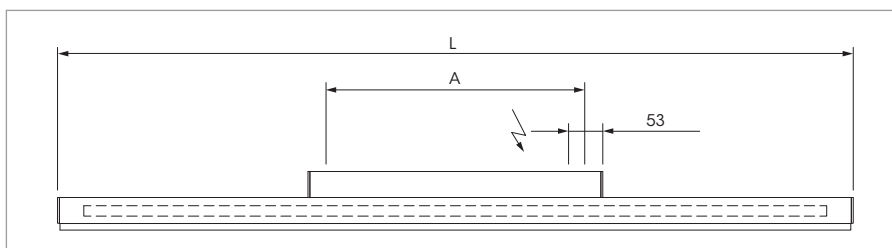



Pendelleuchte, Alu-Profil 40x40mm farblos eloxiert, mit eingelegtem klarem Acrylglas, einseitig matt. Inklusive 2 Stahlseilabhängungen, L=2000mm.

Suspended luminaire, aluminium profile 40x40mm, natural anodized with clear acrylic laid-in diffuser, matt on one side. 2 steel wire suspensions L=2000mm are included.

Luminaire suspendu, profilé en aluminium 40x40mm, anodisé nature, avec verre acrylique clair, un face mat. 2 suspensions à câble d'acier inclus, L=2000mm.

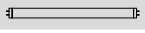
Art. No.		A [mm]	L [mm]
4711GS-1217	1 x 21 W T5	400	981
4711GS-1287	1 x 28 W T5	400	1281

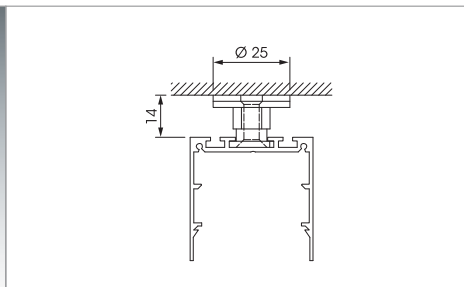
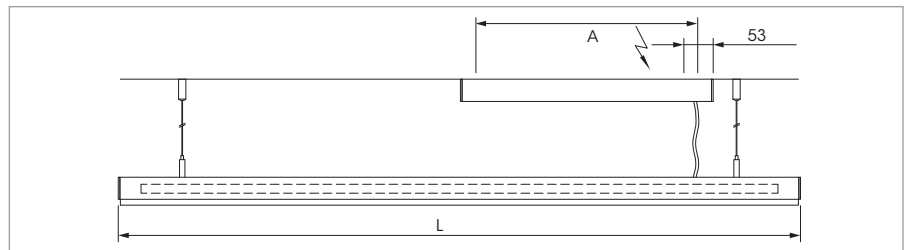

Art. No.
4512

Befestigungsflansch für die Montage der Leuchten an die Decke mit einem Abstand von 14mm [pro Leuchte 2 Stück bestellen].

Flange fitting for ceiling mounting at a distance of 14mm [2 pieces per luminaire].

Bride de fixation pour le montage au plafond avec une distance de 14mm [à commander 2 pièces par luminaire].

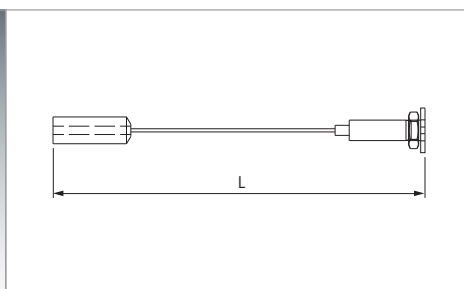
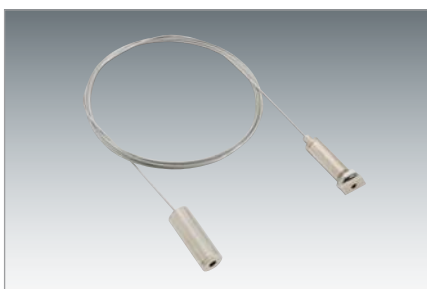

Art. No.	L [mm]
4511	max. 2000

Stahlseilabhängung.

Suspension wire.

Suspension à câble d'acier.

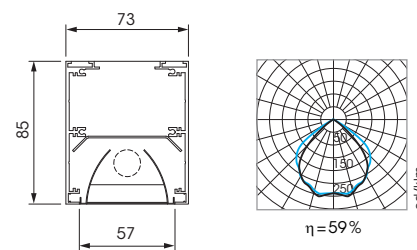
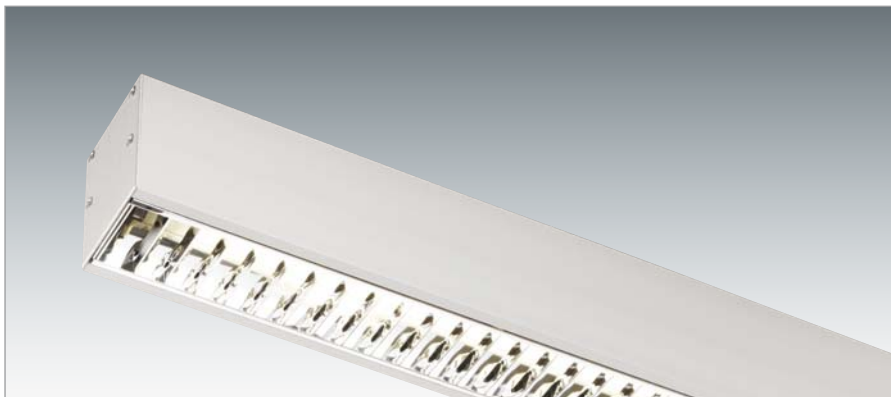

Anbau- und Pendelleuchte, Alu-Profil farblos eloxiert in 1-, 2- und 3-längiger Ausführung. Spiegelrastrer Aluminium hochglanz, rundum entblendet.

Etwas Stahlseilabhängung bitte separat bestellen.

Suspended and surface mounted luminaire, aluminium profile natural anodized, available in single-, dual- and triple-length.

Mirror louvre, highly polished aluminium, glare free. Please order any relevant steel wire suspensions separately.

Luminaire apparent et suspendu, profilé en aluminium, anodisé nature en version mono, duo et triple longueurs.

Ecran en aluminium miroité poli brillant, non-éblouissant de toutes les directions. Veuillez s.v.p commander séparément des suspensions à câble d'acier.

Art. No.		A [mm]	L [mm]
1-längig	single-length	mono longueur	
4210HB-1287	1x1x28W T5	900	1184
4210HB-1547	1x1x54W T5	900	1184
4210HB-1357	1x1x35W T5	1200	1484
4210HB-1807	1x1x80W T5	1200	1484

Art. No.		A [mm]	L [mm]
2-längig	dual-length	duo longueur	
4220HB-2287	2x1x28W T5	900	2364
4220HB-2547	2x1x54W T5	900	2364
4220HB-2357	2x1x35W T5	1200	2964
4220HB-2807	2x1x80W T5	1200	2964

Art. No.		A [mm]	L [mm]
3-längig	triple-length	triple longueur	
4230HB-3287	3x1x28W T5	900	3544
4230HB-3547	3x1x54W T5	900	3544
4230HB-3357	3x1x35W T5	1200	4444
4230HB-3807	3x1x80W T5	1200	4444

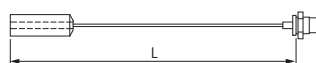
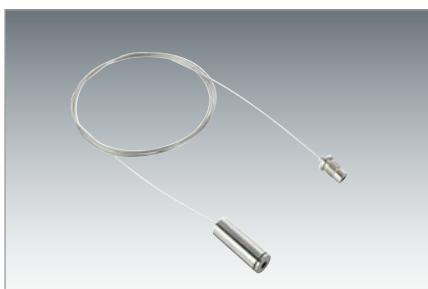
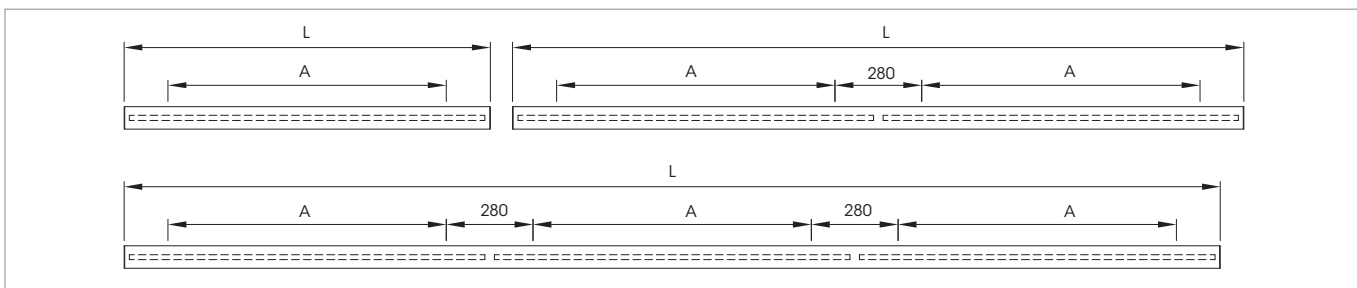

Art. No.	L [mm]
4211	max. 2000

Stahlseilabhängung.

Bestellmenge:

- 2 Stück für 1-längige Leuchten.
- mind. 2 Stück für 2-längige Leuchten.
- mind. 3 Stück für 3-längige Leuchten.

Suspension wire.

Order quantities:

- 2 units for single-length luminaires.
- minimum of 2 units for double-length luminaires.
- minimum of 3 units for triple-length luminaires.

Suspension à câble d'acier.

Quantités à commander:

- 2 pièces pour luminaires mono.
- minimum 2 pièces pour luminaires duo.
- minimum 3 pièces pour luminaires triple.

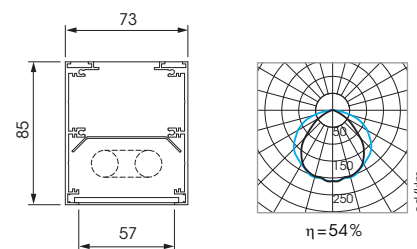

Anbau- und Pendelleuchte, Alu-Profil farblos eloxiert, in 1-, 2-, und 3-längiger Ausführung. Die Leuchten sind mit versetzt angeordneten Fassungen versehen für eine homogene, durchgehende Ausstrahlung. Acrylglas-Abdeckung opal. Etwaige Stahlseilabhängung bitte separat bestellen.

Suspended and surface mounted luminaire, aluminium profile natural anodized, available in single-, dual- and triple-length. The luminaires have off-set mounted sockets in order to get a homogeneous, continuous lighting. Opal acrylic diffuser. Please order any relevant steel wire suspensions separately.

Luminaire apparent et suspendu, profilé en aluminium, anodisé nature, en version mono, duo et triple longueur. Les luminaires sont équipés de culots montés en biais pour arriver à une répartition lumineuse homogène et en continue. Diffuseur en verre acrylique opale. Veuillez s.v.p commander séparément des suspensions à câble d'acier.

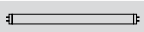
Art. No.		A [mm]	L [mm]
1-längig	single-length	mono longueur	
4212WS-1287	1 x 1 x 28W T5	900	1184
4212WS-1547	1 x 1 x 54W T5	900	1184
4212WS-1357	1 x 1 x 35W T5	1200	1484
4212WS-1807	1 x 1 x 80W T5	1200	1484

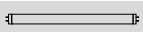
Art. No.		A [mm]	L [mm]
2-längig	dual-length	duo longueur	
4222WS-2287	2 x 1 x 28W T5	900	2294
4222WS-2547	2 x 1 x 54W T5	900	2294
4222WS-2357	2 x 1 x 35W T5	1200	2894
4222WS-2807	2 x 1 x 80W T5	1200	2894

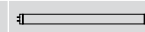
Art. No.		A [mm]	L [mm]
3-längig	triple-length	triple longueur	
4232WS-3287	3 x 1 x 28W T5	900	3404
4232WS-3547	3 x 1 x 54W T5	900	3404
4232WS-3357	3 x 1 x 35W T5	1200	4304
4232WS-3807	3 x 1 x 80W T5	1200	4304

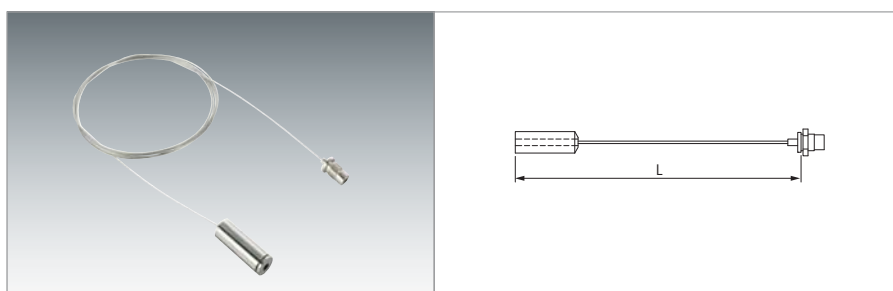
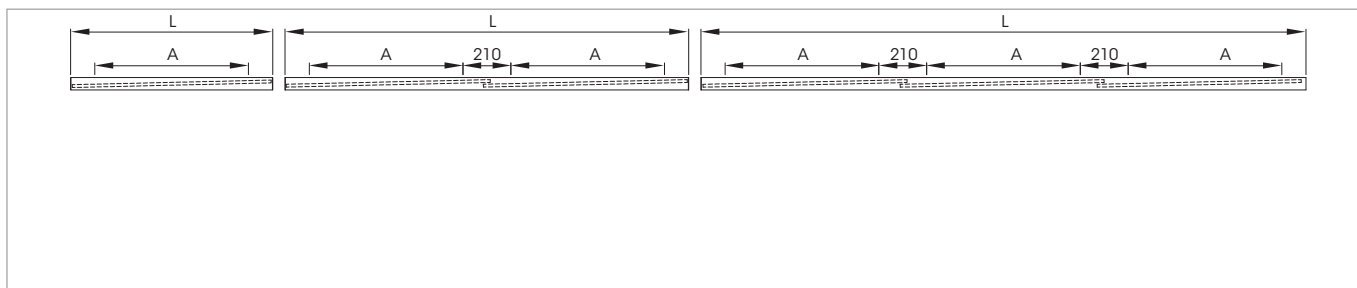

Stahlseilabhängung.
Bestellmenge:
• 2 Stück für 1-längige Leuchten.
• mind. 2 Stück für 2-längige Leuchten.
• mind. 3 Stück für 3-längige Leuchten.

Suspension wire.
Order quantities:
• 2 units for single-length luminaires.
• minimum of 2 units for double-length luminaires.
• minimum of 3 units for triple-length luminaires.

Art. No.	L [mm]
4211	max. 2000

Suspension à câble d'acier.
Quantités à commander:
• 2 pièces pour luminaires mono.
• minimum 2 pièces pour luminaires duo.
• minimum 3 pièces pour luminaires triple.

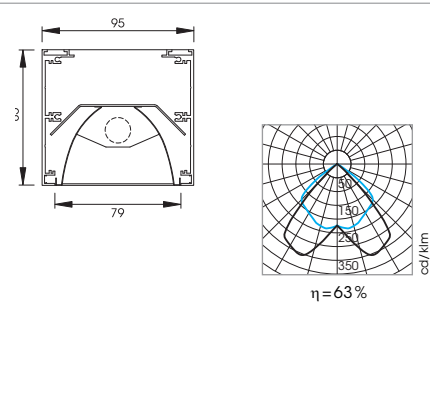



Anbau- und Pendelleuchte, Alu-Profil farblos eloxiert in 1-, 2- und 3-längiger Ausführung. Spiegelraster Aluminium hochglanz, rundum entblendet. Etwaige Stahlseilabhängung bitte separat bestellen.

Suspended and surface mounted luminaire, aluminium profile natural anodized, available in single-, dual- and triple-length. Mirror louvre, highly polished aluminium, glare free. Please order any relevant steel wire suspensions separately.

Luminaire apparent et suspendu, profilé en aluminium, anodisé nature, en version mono, duo et triple longueurs. Ecran en aluminium miroité poli brillant, non-éblouissant de toutes les directions. Veuillez s.v.p commander séparément des suspensions à câble d'acier.

Art. No.		A [mm]	L [mm]
1-längig single-length mono longueur			
4260HB-1287	1x1x28W T5	900	1184
4260HB-1547	1x1x54W T5	900	1184
4260HB-1357	1x1x35W T5	1200	1484
4260HB-1807	1x1x80W T5	1200	1484

Art. No.		A [mm]	L [mm]
2-längig dual-length duo longueur			
4270HB-2287	2x1x28W T5	900	2364
4270HB-2547	2x1x54W T5	900	2364
4270HB-2357	2x1x35W T5	1200	2964
4270HB-2807	2x1x80W T5	1200	2964

Art. No.		A [mm]	L [mm]
3-längig triple-length triple longueur			
4280HB-3287	3x1x28W T5	900	3544
4280HB-3547	3x1x54W T5	900	3544
4280HB-3357	3x1x35W T5	1200	4444
4280HB-3807	3x1x80W T5	1200	4444

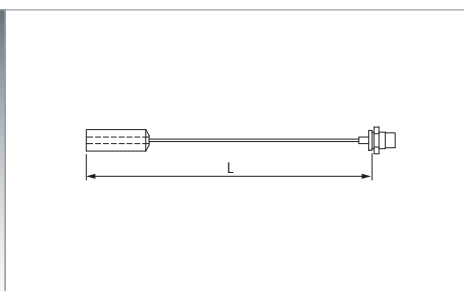
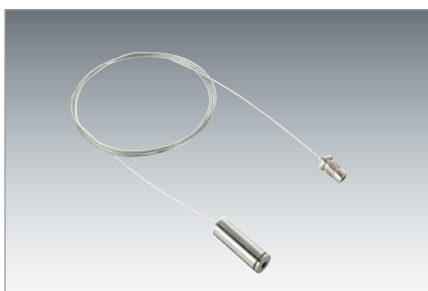
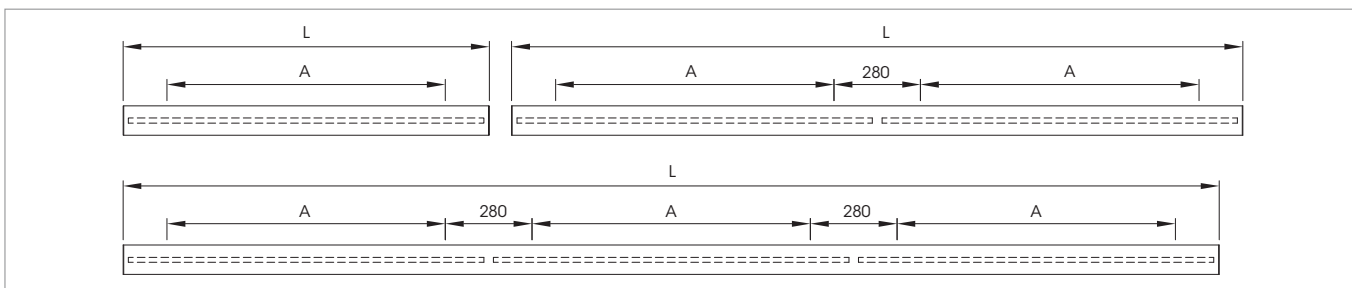

Art. No.	L [mm]
4211	max. 2000

Stahlseilabhängung.
Bestellmenge:
• 2 Stück für 1-längige Leuchten.
• mind. 2 Stück für 2-längige Leuchten.
• mind. 3 Stück für 3-längige Leuchten.

Suspension wire.
Order quantities:
• 2 units for single-length luminaires.
• minimum of 2 units for double-length luminaires.
• minimum of 3 units for triple-length luminaires.

Suspension à câble d'acier.
Quantités à commander:
• 2 pièces pour luminaires mono.
• minimum 2 pièces pour luminaires duo.
• minimum 3 pièces pour luminaires triple.

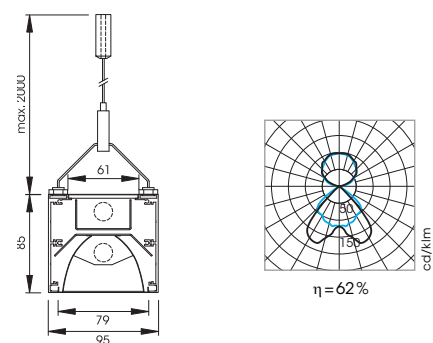
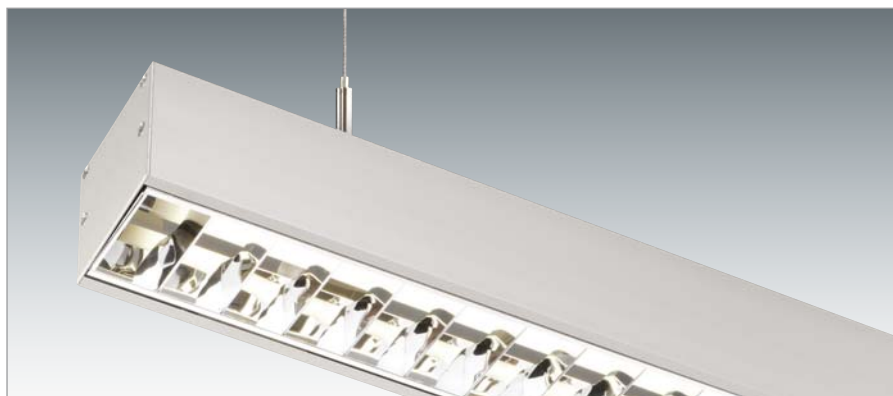

Pendelleuchte, Alu-Profil farblos eloxiert, in 1-, 2- und 3-längiger Ausführung. Mit je einer Lampe direkt und indirekt strahlend auf separate Klemme geführt. Direkt-Anteil mit Spiegelraster Aluminium hochglanz, rundum entblendet; Indirekt-Anteil mit weißem Reflektor.

Suspended luminaire, aluminium profile, natural anodized, available in single-, dual and triple-length. Equipped with one direct and one indirect lamp and each with a separate terminal. The direct part is equipped with a glare free, highly polished aluminium mirror louvre; the indirect part has a white reflector.

Luminaire suspendu, profilé en aluminium, anodisé nature, en version mono, duo et triple longueurs. Equipé d'une lampe directe et une indirecte, chacune branchée sur borne de raccordement individuelle. La partie directe passe par le l'écran en aluminium miroité poli brillant, non-éblouissant de toutes les directions; la partie indirecte passe par un réflecteur blanc.

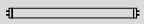
Art. No.		A [mm]	L [mm]
1-längig	single-length	mono	longueur
4261DI-2287	1 x 2x 28 W T5	900	1184
4261DI-2357	1 x 2x 35 W T5	1200	1484

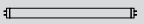
Art. No.		A [mm]	L [mm]
2-längig	dual-length	duo	longueur
4271DI-4287	2 x 2x 28 W T5	900	2364
4271DI-4357	2 x 2x 35 W T5	1200	2964

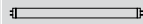
Art. No.		A [mm]	L [mm]
3-längig	triple-length	triple	longueur
4281DI-6287	3 x 2x 28 W T5	900	3544
4281DI-6357	3 x 2x 35 W T5	1200	4444

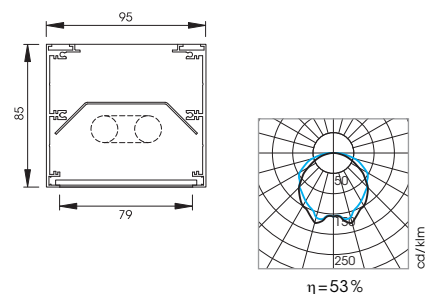
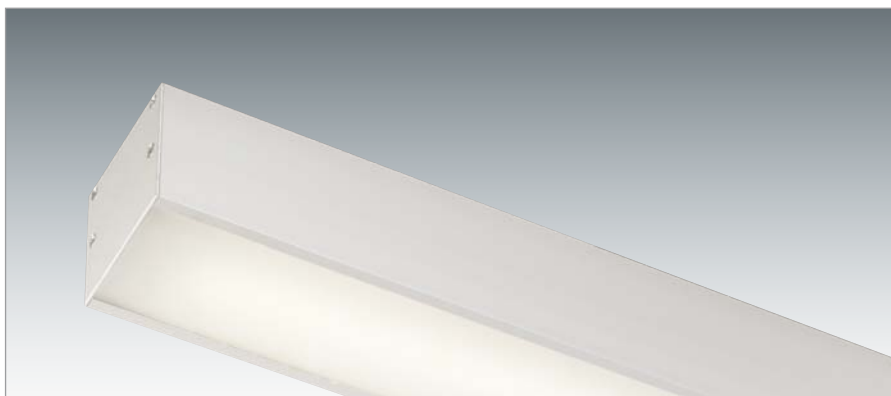

Anbau- und Pendelleuchte, Alu-Profil farblos eloxiert, in 1-, 2- und 3-längiger Ausführung. Die Leuchten sind mit versetzt angeordneten Fassungen versehen für eine homogene, durchgehende Ausstrahlung. Acrylglas-Abdeckung opal. Etwaige Stahlseilabhängung bitte separat bestellen.

Suspended and surface mounted luminaire, aluminium profile natural anodized, available in single-, dual- and triple-length. The luminaires have off-set mounted sockets in order to get a homogeneous, continuous lighting. Opal acrylic diffuser. Please order any relevant steel wire suspensions separately.

Luminaire apparent et suspendu, profilé en aluminium, anodisé nature, en version mono, duo et triple longueurs. Les luminaires sont équipés de colots montés en biais pour arriver à une répartition lumineuse homogène et en continue. Diffuseur en verre acrylique opale. Veuillez s.v.p commander séparément des suspensions à câble d'acier.

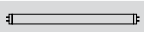
Art. No.		A [mm]	L [mm]
1-längig	single-length	mono longueur	
4262WS-1287	1 x 1 x 28W T5	900	1184
4262WS-1547	1 x 1 x 54W T5	900	1184
4262WS-1357	1 x 1 x 35W T5	1200	1484
4262WS-1807	1 x 1 x 80W T5	1200	1484

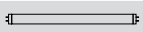
Art. No.		A [mm]	L [mm]
2-längig	dual-length	duo longueur	
4272WS-2287	2 x 1 x 28W T5	900	2294
4272WS-2547	2 x 1 x 54W T5	900	2294
4272WS-2357	2 x 1 x 35W T5	1200	2894
4272WS-2807	2 x 1 x 80W T5	1200	2894

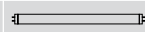
Art. No.		A [mm]	L [mm]
3-längig	triple-length	triple longueur	
4282WS-3287	3 x 1 x 28W T5	900	3404
4282WS-3547	3 x 1 x 54W T5	900	3404
4282WS-3357	3 x 1 x 35W T5	1200	4304
4282WS-3807	3 x 1 x 80W T5	1200	4304

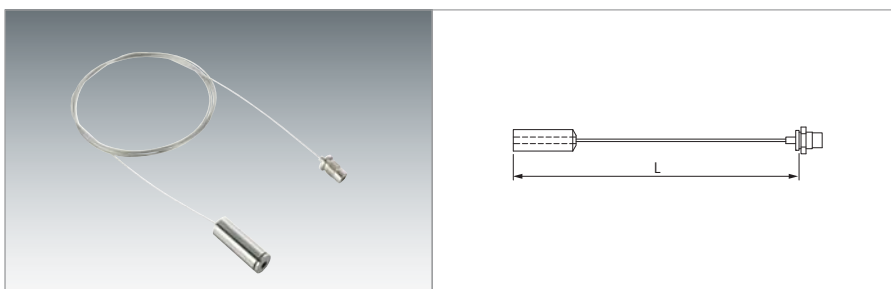
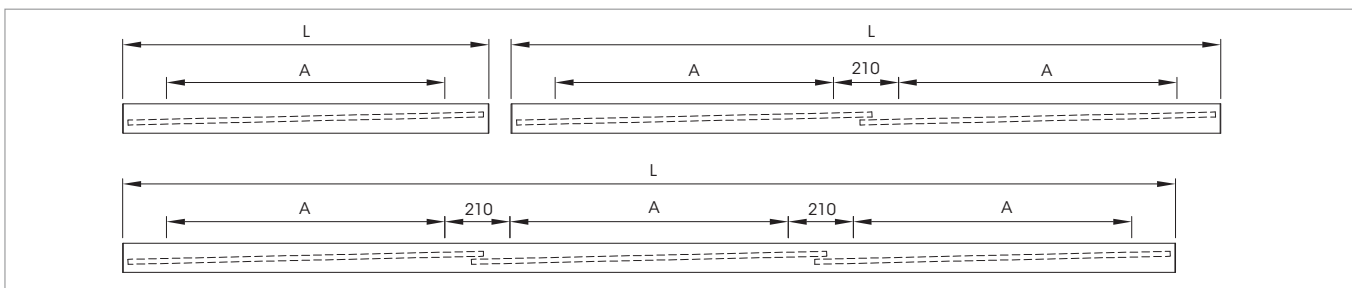

Art. No.	L [mm]
4211	max. 2000

Stahlseilabhängung.
Bestellmenge:
• 2 Stück für 1-längige Leuchten.
• mind. 2 Stück für 2-längige Leuchten.
• mind. 3 Stück für 3-längige Leuchten.

Suspension wire.
Order quantities:
• 2 units for single-length luminaires.
• minimum of 2 units for double-length luminaires.
• minimum of 3 units for triple-length luminaires.

Suspension à câble d'acier.
Quantités à commander:
• 2 pièces pour luminaires mono.
• minimum 2 pièces pour luminaires duo.
• minimum 3 pièces pour luminaires triple.

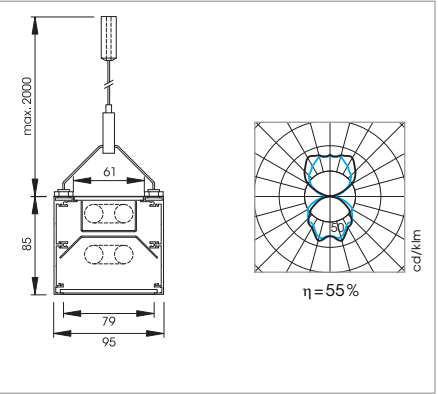
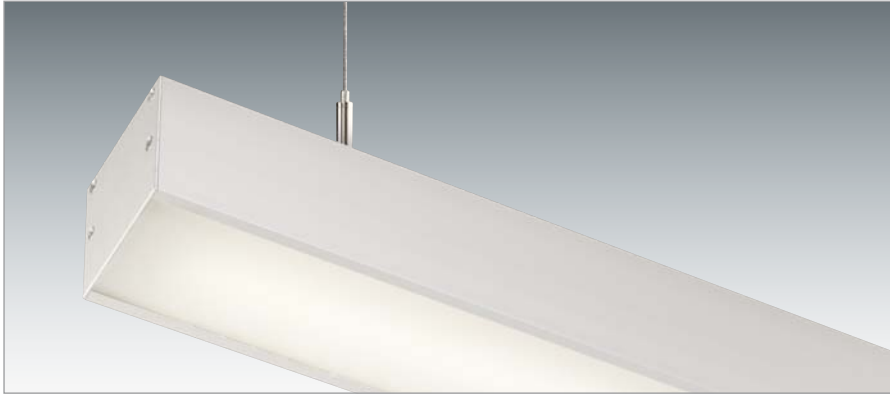

Pendelleuchte, Alu-Profil farblos eloxiert, in 1-, 2- und 3-längiger Ausführung. Mit je einer Lampe direkt und indirekt strahlend auf separate Klemme geführt. Die Leuchten sind mit versetzt angeordneten Fassungen versehen für eine homogene, durchgehende Ausstrahlung. Direkt-Anteil mit weißem Reflektor und Acrylglasabdeckung opal; Indirekt-Anteil mit weißem Reflektor.

Suspended luminaire, aluminium profile natural anodized, available in single-, dual and triple-length. Equipped with one direct and one indirect lamp and each with a separate terminal. The luminaires have off-set mounted sockets in order to get a homogeneous, continuous lighting. The direct part is equipped with a white reflector and an opal acrylic diffuser; the indirect part has a white reflector.

Luminaire suspendu, profilé en aluminium, anodisé nature, en version mono, duo et triple longueurs. Equipé d'une lampe directe et une indirecte, chacune branchée sur borne de raccordement individuelle. Les luminaires sont équipés de culots montés en biais pour arriver à une répartition lumineuse homogène et en continue. La partie directe passe par un réflecteur blanc et un diffuseur en acrylique opale, la partie indirecte passe par un réflecteur blanc.

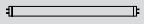
Art. No.		A [mm]	L [mm]
1-längig	single-length	mono	longueur
4263DI-2287	1x2x28W T5	900	1184
4263DI-2357	1x2x35W T5	1200	1484

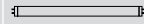
Art. No.		A [mm]	L [mm]
2-längig	dual-length	duo	longueur
4273DI-4287	2x2x28W T5	900	2294
4273DI-4357	2x2x35W T5	1200	2894

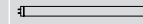
Art. No.		A [mm]	L [mm]
3-längig	triple-length	triple	longueur
4283DI-6287	3x2x28W T5	900	3404
4283DI-6357	3x2x35W T5	1200	4304

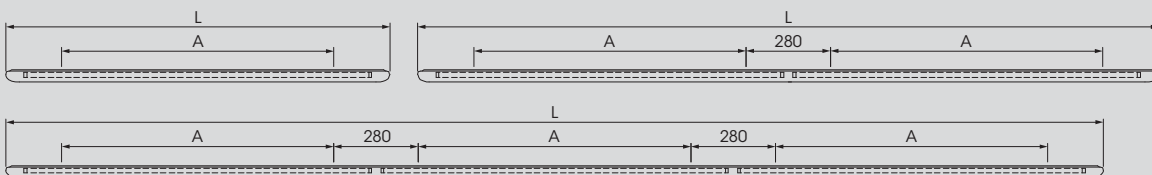

A ... Seilabhängung variabel
 A ... variable for cable suspension
 A ... pour fixation à fils variable

$A_{\max} = L - 280\text{mm}$

A ... für Deckenmontage siehe 0-4400-T.
 A ... for ceiling mounting see 0-4400-T.
 A ... pour fixation au plafond voir 0-4400-T.

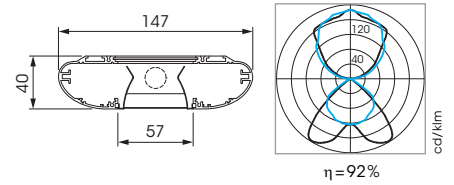
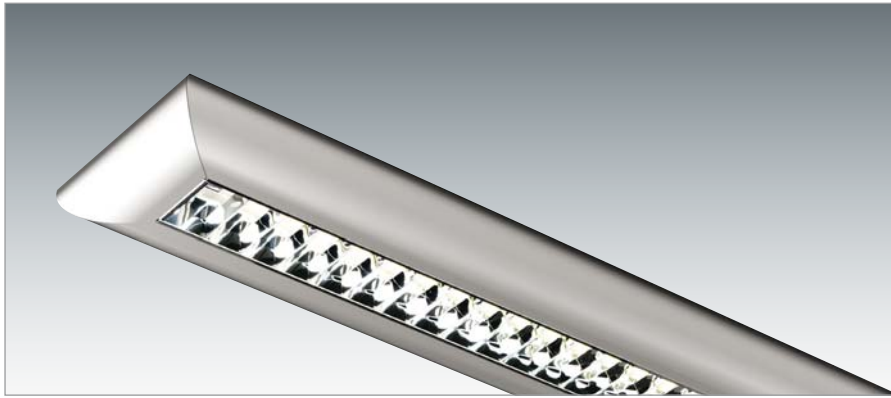

Direkt/indirekt strahlende Spiegelraster-Anbau- und Pendelleuchte, Alu-Profil farblos eloxiert, in 1-, 2- und 3-längiger Ausführung.
Spiegelraster Aluminium hochglanz, rundum entblendet.

Surface mounted or pendant direct/indirect luminaire with mirror louvre, aluminium profile natural anodised, available in single-, dual- and triple-length. Mirror louvre, highly polished aluminium, glare free.

Luminaire apparent et suspendu à écran miroité pour éclairage direct/indirect, profilé en aluminium anodisé nature, en version mono, duo et triple longueurs.

Ecran en aluminium miroité poli brillant, non-éblouissant de toutes les directions.

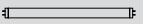
Art. No.		L [mm]
1-längig single-length mono longueur		
4410HB-1287	1x28W T5	1270
4410HB-1547	1x54W T5	1270
4410HB-1357	1x35W T5	1570
4410HB-1807	1x80W T5	1570

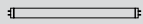
Art. No.		L [mm]
2-längig dual-length duo longueur		
4420HB-2287	2x1x28W T5	2450
4420HB-2547	2x1x54W T5	2450
4420HB-2357	2x1x35W T5	3050
4420HB-2807	2x1x80W T5	3050

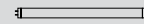
Art. No.		L [mm]
3-längig triple-length triple longueur		
4430HB-3287	3x1x28W T5	3630
4430HB-3547	3x1x54W T5	3630
4430HB-3357	3x1x35W T5	4530
4430HB-3807	3x1x80W T5	4530

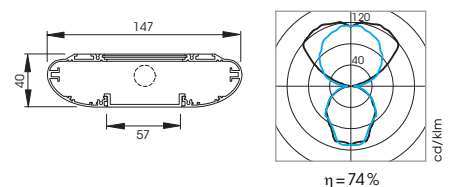
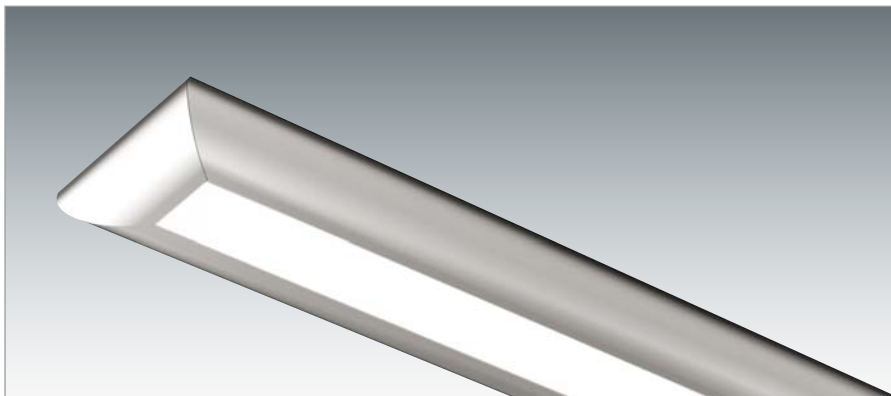



Direkt/indirekt strahlende Anbau- und Pendelleuchte, Alu-Profil farblos eloxiert, in 1-, 2- und 3-längiger Ausführung.
Acrylglas satiné.

Surface mounted or pendant direct/indirect luminaire, aluminium profile natural anodised, available in single-, dual- and triple-length. Acrylic diffuser satiné.

Luminaire apparent et suspendu pour éclairage direct/indirect, profilé en aluminium anodisé nature, en version mono, duo et triple longueurs.
Diffuseur en verre acrylique, satiné.

Art. No.		L [mm]
1-längig single-length mono longueur		
4410GS-1287	1x28W T5	1270
4410GS-1547	1x54W T5	1270
4410GS-1357	1x35W T5	1570
4410GS-1807	1x80W T5	1570

Art. No.		L [mm]
2-längig dual-length duo longueur		
4420GS-2287	2x1x28W T5	2450
4420GS-2547	2x1x54W T5	2450
4420GS-2357	2x1x35W T5	3050
4420GS-2807	2x1x80W T5	3050

Art. No.		L [mm]
3-längig triple-length triple longueur		
4430GS-3287	3x1x28W T5	3630
4430GS-3547	3x1x54W T5	3630
4430GS-3357	3x1x35W T5	4530
4430GS-3807	3x1x80W T5	4530



Dreipunkt-Seilaufhängung.
2 Stück für 1-längige Leuchten,
mindestens 2 Stück für 2-längige Leuchten,
mindestens 3 Stück für 3-längige Leuchten.

Tree-point cable suspension.
2 units for single-length luminaires,
minimum of 2 units for double-length luminaires,
minimum of 3 units for triple-length luminaires.

Art. No.	L [mm]
4011	max. 2000

Câble de suspension à trois points.
2 pièces pour luminaires mono longueur,
minimum 2 pièces pour luminaires duo longueur,
minimum 3 pièces pour luminaires triple longueur.

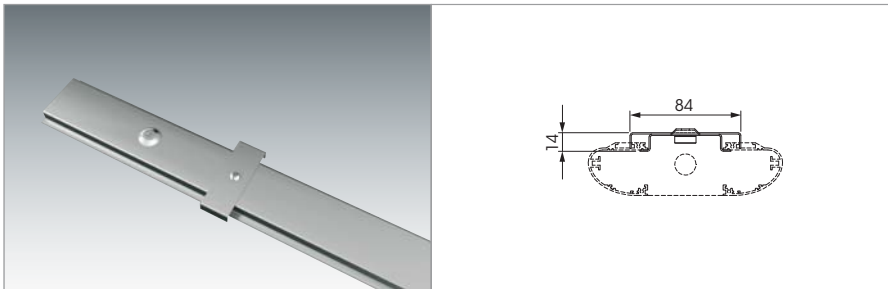

Deckenhalterung aus Stahlblech.
1 Stück für 1-längige Leuchten,
2 Stück für 2-längige Leuchten,
3 Stück für 3-längige Leuchten.

Ceiling mounting steel plate.
1 unit for single-length luminaires,
2 units for double-length luminaires,
3 units for triple-length luminaires.

Art. No.	☰	A [mm]	L [mm]
4400-T69	28W/54W T5	900	1178
4400-T89	35W/80W T5	1200	1478

Support de fixation au plafond en tôle.
1 pièce pour luminaires mono longueur,
2 pièces pour luminaires duo longueur,
3 pièces pour luminaires triple longueur.

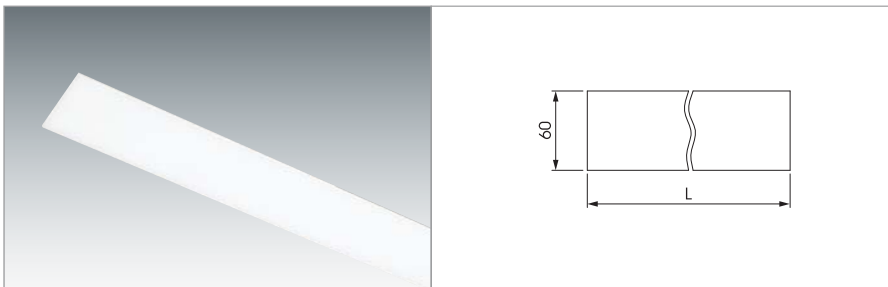

Acrylglasabdeckung opal für die Blendungsbegrenzung des Indirekt-Anteils.

Opal acrylic glass cover for glare reduction of the indirect section.

Art. No.	☰	L [mm]
4410-G69	28W/54W T5	1180
4410-G89	35W/80W T5	1480

Cache en verre acrylique opale pour limiter l'éblouissement de la partie indirecte.

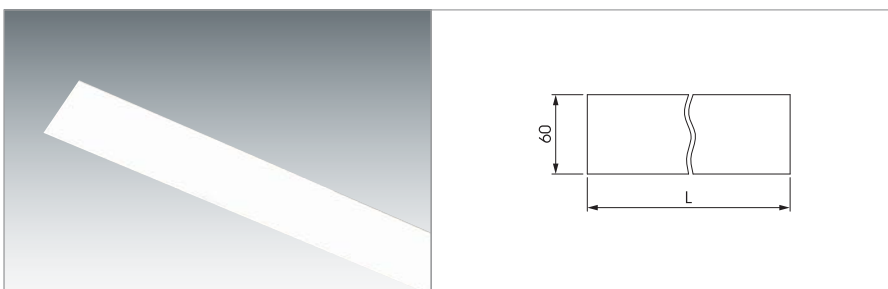

Blechabdeckung weiß für reine Direktstrahlung.

White cover plate for direct illumination.

Art. No.	☰	L [mm]
4410-C69	28W/54W T5	1180
4410-C89	35W/80W T5	1480

Cache en tôle blanche pour un rayonnement direct.

LIGHTLINE

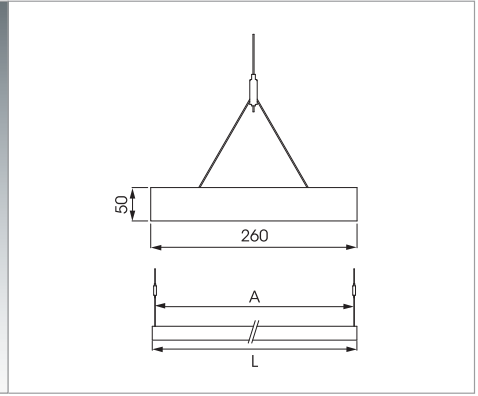
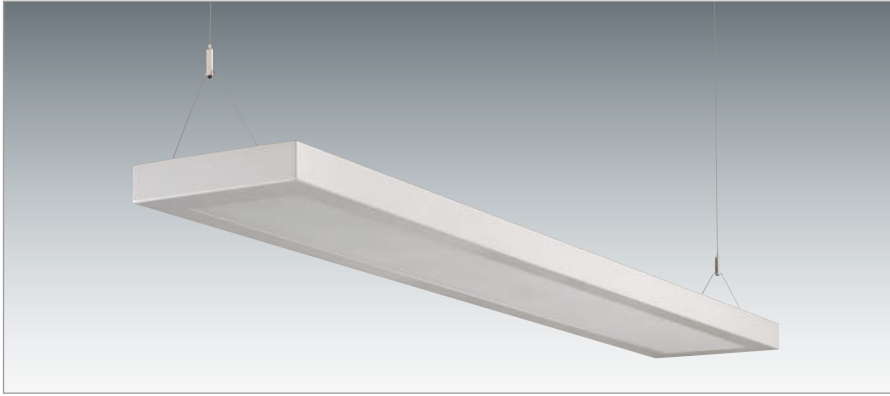

Indirektleuchte im flachen Rechteckprofil aus Stahlblech RAL 9006 grau pulverbeschichtet. BAP-gerechte Aufhellung des Leuchtenprofils durch Lochblech. Geeignet für geringe Abhängehöhen. Abhängung beidseitig mit Y-Stahlseil mit Höhenverstellung.

Indirect luminaire in a flat rectangular profile made of steel plate, grey RAL 9006 powder coated. Illumination of the light profile, according to LG3 class II categorisation by means of a perforated metal sheet diffuser. Suitable for low suspension heights. Suspended on both ends by means of Y-steel wires with height adjustment.

Luminaire indirecte en profilé tôle d'acier plat, poudre gris RAL 9006. L'éclairage du profilé est fait par un diffuseur en plaque d'acier perforée, sans reflets, conforme aux réglementations pour un poste de travail avec écran. Adapter pour des hauteurs de suspension réduites. Suspended des 2 extrémités par câble d'acier Y, avec réglage en hauteur.

Art. No.		A [mm]	L [mm]
Light-1254-42	2x54W T5	1250	1270
Light-1354-43	3x54W T5	1250	1270
Light-1280-45	2x80W T5	1550	1570
Light-1380-46	3x80W T5	1550	1570

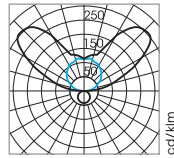

2xT5 η=91%

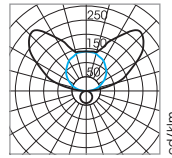

3xT5 η=86%

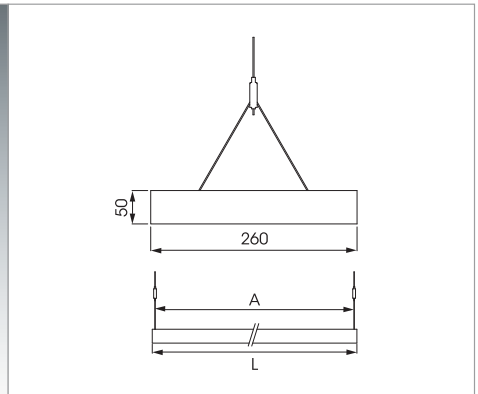
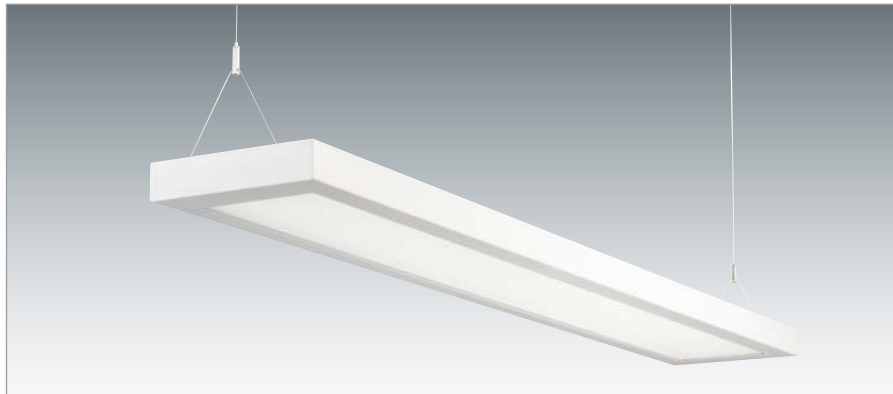

Indirektleuchte im flachen Rechteckprofil aus Stahlblech matt weiß pulverbeschichtet. BAP-gerechte Aufhellung des Leuchtenprofils durch Opalglasabdeckung. Geeignet für geringe Abhängehöhen. Abhängung beidseitig mit Y-Stahlseil mit Höhenverstellung.

Indirect luminaire in a flat rectangular profile made of steel plate, matt white powder coated. Illumination of the light profile, according to LG3 class II categorisation by means of an opal glass diffuser. Suitable for low suspension heights. Suspended on both ends by means of Y-steel wires with height adjustment.

Luminaire indirecte en profilé tôle d'acier plat, poudre blanc mat. L'éclairage du profilé est fait par un diffuseur en verre acrylique opale, conforme aux réglementations pour un poste de travail avec écran. Adapter pour des hauteurs de suspension réduites. Suspended des 2 extrémités par câble d'acier Y, avec réglage en hauteur.

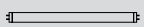
Art. No.		A [mm]	L [mm]
Light-1254-32	2x54W T5	1250	1270
Light-1354-33	3x54W T5	1250	1270
Light-1280-35	2x80W T5	1550	1570
Light-1380-36	3x80W T5	1550	1570

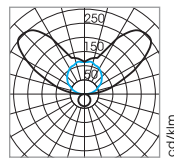

2xT5 η=91%

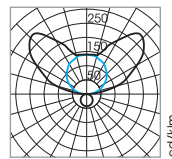

3xT5 η=86%



Indirektleuchte im flachen Rechteckprofil aus Stahlblech matt weiß pulverbeschichtet. Geeignet für geringe Abhängehöhen. Abhängung beidseitig mit Y-Stahlseil mit Höhenverstellung.

Indirect luminaire in a flat rectangular profile made of steel plate, matt white powder coated. Suitable for low suspension heights. Suspended on both ends by means of Y-steel wires with a height adjustment.

Luminaire indirecte en profilé tôle d'acier plat, poudré blanc mat. Adapter pour des hauteurs de suspension réduites. Suspendu des 2 extrémités par câble d'acier Y, avec réglage en hauteur.

Art. No.		A [mm]	L [mm]
Light-1154-71	1x54W T5	1330	1350
Light-1254-72	2x54W T5	1330	1350
Light-1354-73	3x54W T5	1330	1350
Light-1180-74	1x80W T5	1630	1650
Light-1280-75	2x80W T5	1630	1650
Light-1380-76	3x80W T5	1630	1650

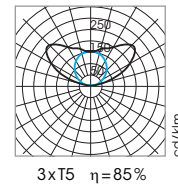
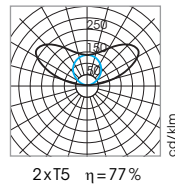
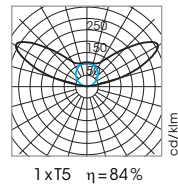

ZUBEHÖR ACCESSORIES ACCESSOIRES

Stahlseil [pro Leuchte 2 Stück bestellen]

Steel wire [2 pieces per luminaire to be ordered]

Suspension à câble d'acier [2 pièces par luminaire à commander]

Deckenhalter [pro Leuchte 2 Stück bestellen]

Ceiling plate [2 pieces per luminaire to be ordered]

Rosace [2 pièces par luminaire à commander]

Art. No.	L [mm]
OK3-1000	1000

Art. No.
OK4EA

PEGASUS

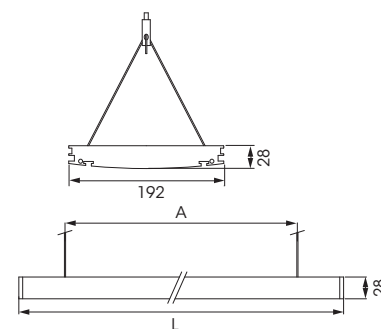

Schlanke Aluminiumprofileuchte in weiß matt für moderne Bildschirmarbeitsplätze mit rein indirekt symmetrisch strahlender Lichtverteilung. Leuchte komplett mit Y-Stahlseilabhangung.

Slim aluminium-profile luminaire for modern work places, with indirect symmetrical light distribution. Luminaire complete with Y-steel wire suspension.

Luminaire en profilé aluminium extrudé extra plat, pour postes de travail moderne à écran avec éclairage indirect symétrique. Luminaire complet avec des suspensions à câble d'acier.

Art. No.		A [mm]	L [mm]
Pega-1254-002	2x54W T5	1180	1300
Pega-1280-002	2x80W T5	1480	1600
Pega-1154-002	1x54W T5	1180	1300
Pega-1180-002	1x80W T5	1480	1600

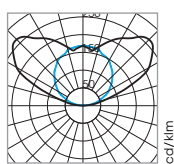



Schlanke Aluminiumprofileuchte in weiß matt für moderne Bildschirmarbeitsplätze mit Parabolraster für direkt/indirekt symmetrisch strahlende Lichtverteilung. Leuchte komplett mit Y-Stahlseilabhängung.

Slim aluminium-profile luminaire for modern work places equipped environment, with direct/indirect symmetrical light distribution. Luminaire complete with Y-steel wire suspension.

Luminaire en profilé aluminium extrudé extra plat, pour postes de travail à écran moderne avec éclairage directe/indirecte symétrique. Luminaire complet avec des suspensions à câble d'acier.

Art. No.		A [mm]	L [mm]
Pega-1154-001	1 x 54 W T5	1180	1300
Pega-1180-001	1 x 80 W T5	1480	1600

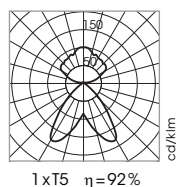

ZUBEHÖR ACCESSORIES ACCESSOIRES

Stahlseil [pro Leuchte 2 Stück bestellen]

Steel wire [2 pieces per luminaire to be ordered]

Suspension à câble d'acier [2 pièces par luminaire à commander]

Deckenhalter [pro Leuchte 2 Stück bestellen]

Ceiling plate [2 pieces per luminaire to be ordered]

Rosace [2 pièces par luminaire à commander]

Art. No.	L [mm]
OK3-1000	1000

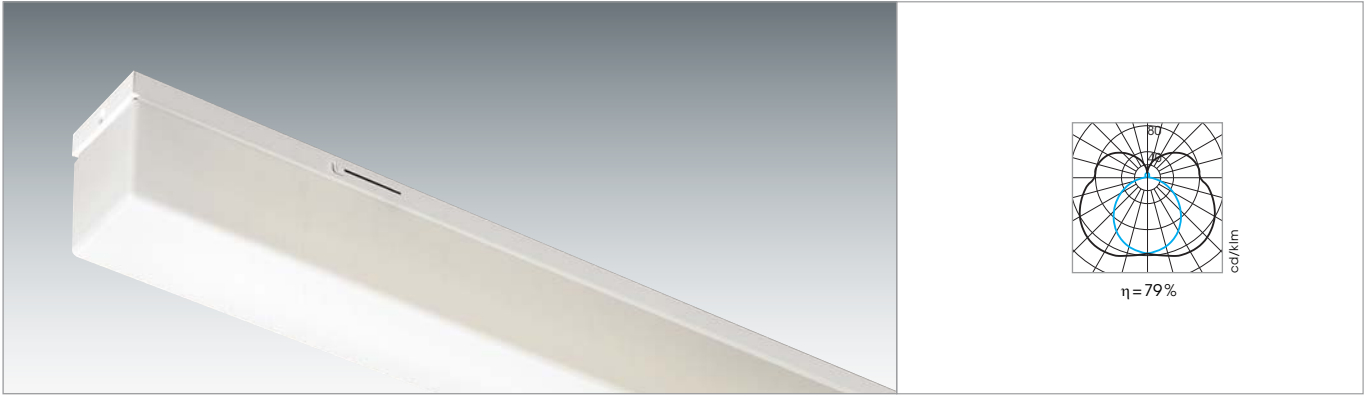

Art. No.
OK4EA



Deckenleuchte, Grundplatte Stahlblech weiß thermolackiert, mit einseitig bedienbaren Riegelverschlüssen, Anschlussklemme 5x4mm². Acrylglaswanne opal.

Surface mounted luminaire, steel base plate white thermocoated, side clips fastening, terminal 5x4mm². Acrylic diffuser opal.

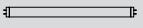
Plafonnier, plaque de base en tôle d'acier, thermolaquée blanc, avec fermetures unilatérale par targettes, borne de raccordement 5x4mm². Diffuseur en verre acrylique opale.

Art. No.		
1088WG-1367	1x36W T26	EVG
1088WG-1587	1x58W T26	EVG

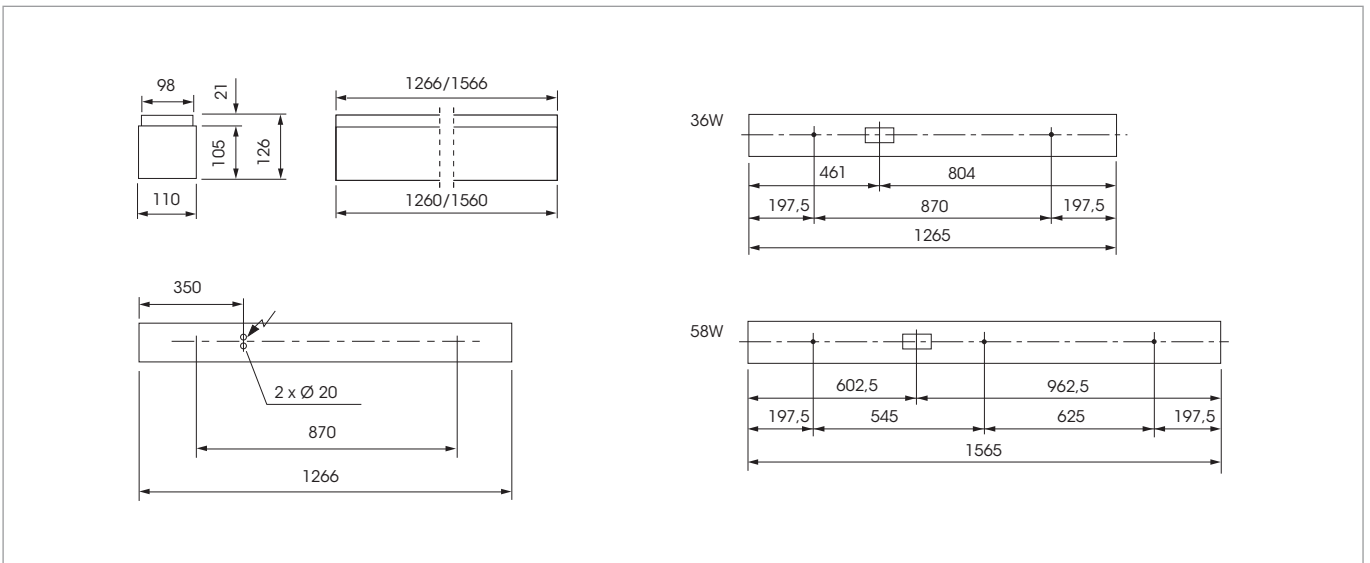

ERSATZ-ZUBEHÖR ACCESSORIES ACCESSOIRES

Ersatzglas.
Spare glass.
Verre de rechange.

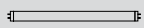

Art. No.		
1088WG-G69	1x36W T26	
1088WG-G89	1x58W T26	



Deckenleuchte, Grundplatte Stahlblech weiß thermolackiert, mit einseitig bedienbaren Riegelverschlüssen, Anschlussklemme 5x4mm². Acrylglaswanne opal.

Surface mounted luminaire, steel base plate white thermocoated, side clips fastening, terminal 5x4mm². Acrylic diffuser opal.

Plafonnier, plaque de base en tôle d'acier, thermolaquée blanc, avec fermetures unilatérale par targettes, borne de raccordement 5x4mm². Diffuseur en verre acrylique opale.

Art. No.		
1089WG-2367	2x36W T26	EVG
1089WG-2587	2x58W T26	EVG

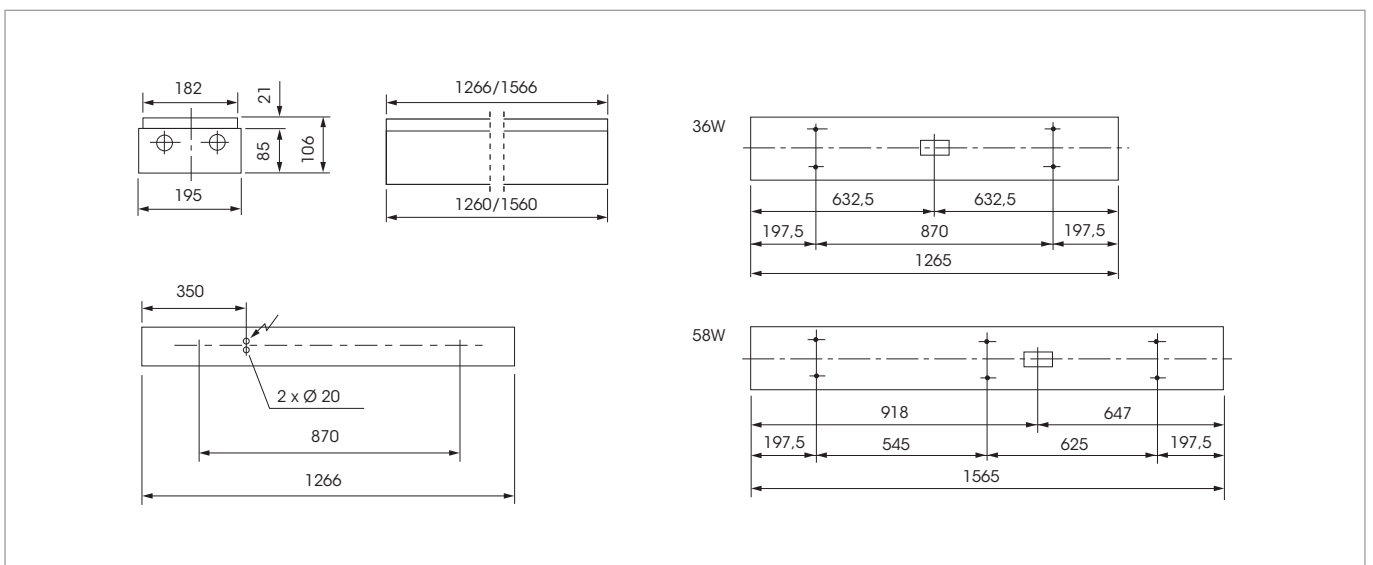

ERSATZ-ZUBEHÖR ACCESSORIES ACCESSOIRES

Ersatzglas.
Spare glass.
Verre de rechange.

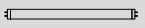
Art. No.		
1089WG-G79	2x36W T26	
1089WG-G99	2x58W T26	