

SYSTEMLEUCHTEN

System lightings
Luminaires de système

2





Photography by Hisao Suzuki

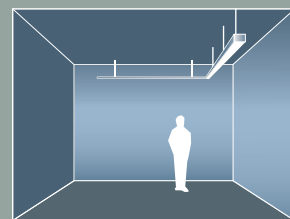
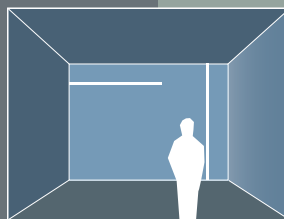
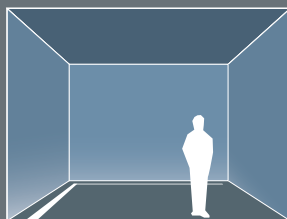
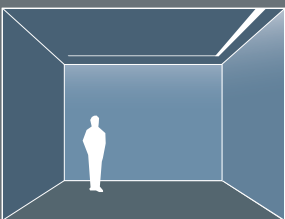

OMEGA 60

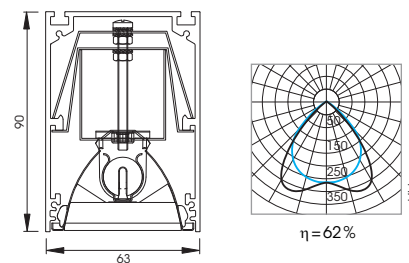

Direkt strahlende Einbau-/Anbauleuchte oder direkt [direkt/indirekt] strahlende Pendelleuchte aus eloxiertem Aluminium mit Parabolraster und EVG.

Direct illuminating recessed/surface mounted luminaire or direct [direct/indirect] illuminating pendant luminaire of anodised aluminium with parabolic raster and EVG [electric series unit].

Luminaire encastré ou en applique à rayonnement direct ou luminaire pendulaire à rayonnement direct [direct/indirect] en aluminium anodisé avec grille parabolique et ballast électronique.

Art. No.		A [mm]	L [mm]
1-längig single-length mono longueur			
OM60-PG.154	1x54W/28W T5	980	1191
OM60-PG.180	1x80W/35W T5	1280	1491

Art. No.		A [mm]	L [mm]
2-längig dual-length duo longueur			
OM60-PG.254	2x54W/28W T5	1080	2377
OM60-PG.280	2x80W/35W T5	1380	2977



Direkt strahlende Einbau-/Anbauleuchte oder direkt [direkt/indirekt] strahlende Pendelleuchte aus eloxiertem Aluminium mit satinierter Abdeckung und EVG.

Direct illuminating recessed/surface mounted luminaire or direct [direct/indirect] illuminating pendant luminaire of anodised aluminium with satinised cover and EVG.

Luminaire encastré ou en applique à rayonnement direct ou luminaire pendulaire à rayonnement direct [direct/indirect] en aluminium anodisé avec diffuseur dépoli et ballast électronique.

Art. No.		A [mm]	L [mm]
1-längig single-length mono longueur			
OM60-GS.154	1x54W/28W T5	980	1191
OM60-GS.180	1x80W/35W T5	1280	1491

Art. No.		A [mm]	L [mm]
2-längig dual-length duo longueur			
OM60-GS.254	2x54W/28W T5	1080	2377
OM60-GS.280	2x80W/35W T5	1380	2977

ZUBEHÖR ACCESSORIES ACCESSOIRES

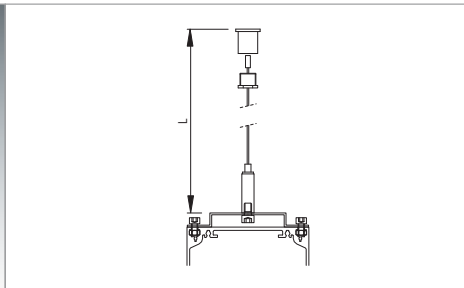
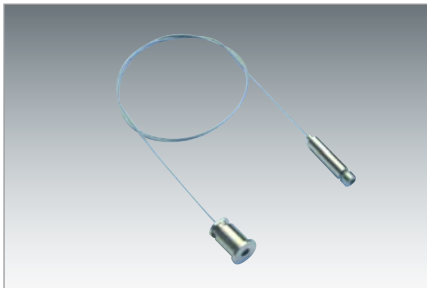

Art. No.	L [mm]
OM60-Z015	1000

Stahlseilabhangung.

Suspension wire.

Suspension à câble d'acier.

OMEGA 76



Photography by Hisao Suzuki

Aluminium-Lichtkanalsystem, eloxiert, basierend auf einem stabilen Grundprofil. In Längen von bis zu 6m lieferbar. Das Profil kann werkseitig mit Gehrungs- oder Eckschnitten hergestellt oder vor Ort geschnitten werden. Abhänge- und Verbindersysteme komplettieren das System.

OMEGA 76 ist bezüglich der Lichttechnik variabel bis hin zu LED-Einsätzen für Bodeneinbau. Andere gebäudetechnische Elemente wie z.B. Notleuchten, Sprinkler, Lautsprecher, Stromschienen etc. können in den Kanal integriert werden.

Für alle gängigen Einbau-, Anbau- sowie Pendelvarianten einsetzbar.

Aluminium channel rail system, anodized, based on a rigid basic profile. Available lengths up to 6m. The profile can be factory machined with mitre joints or corner joints or can be cut to size on site. Suspension and connection systems are completing the system.

Regarding light technology, OMEGA 76 is very flexible even for LED inserts for ground installation. Other elements of building management such as emergency lighting, sprinklers, loudspeakers, current rails, etc. can be integrated into the channel rail.

Suitable for all common recessed, surface mounted as well as suspended variants.

Système de rails à tube d'illumination fabriqué en aluminium anodisé, fondé sur un profilé de base stable. Disponible en longueurs jusqu'à 6m. Le profilé peut être façonné en usine avec des coupes de joints en biais ou droites. Il peut aussi être découpé sur site. Des systèmes de suspension et de connexion complètent le système.

Concernant la technologie d'éclairage, OMEGA 76 est très flexible, même une installation des éléments LED dans le sol est possible. D'autres éléments techniques du bâtiment tels que luminaires de secours, sprinklers, haut-parleurs, rails conducteurs, etc. sont intégrables dans les tubes.

Utilisable pour toutes variantes encastrées, apparentes ou suspendues.

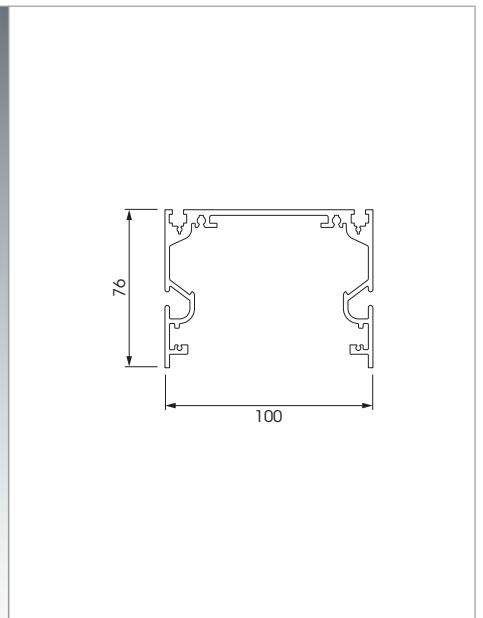
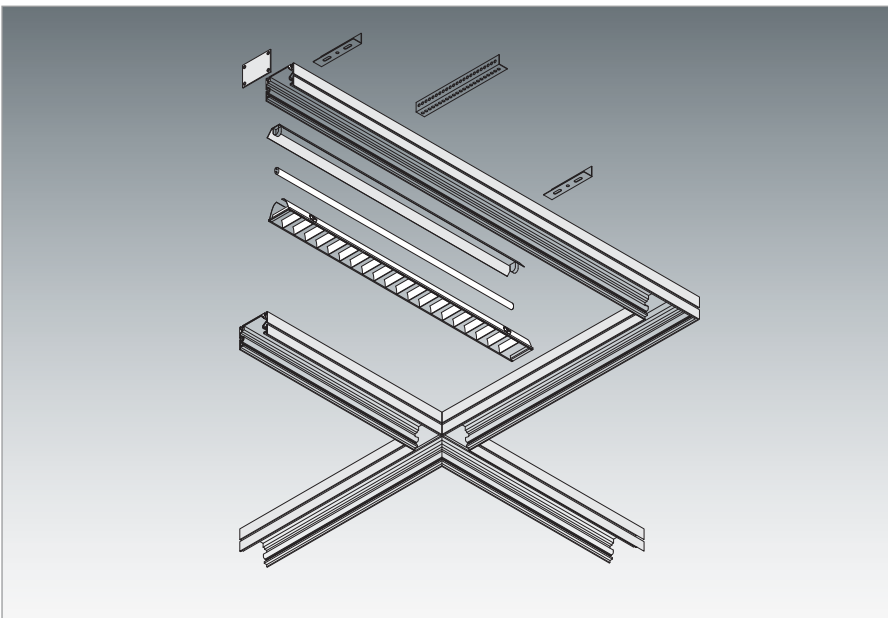

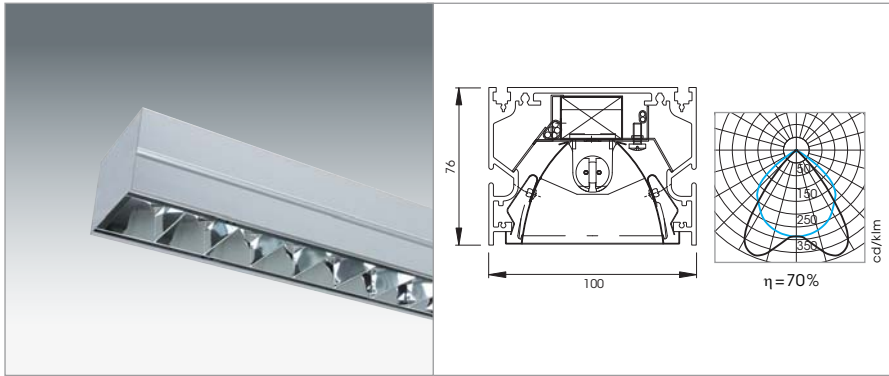

Leuchteneinsatz mit Parabolraster.
[Art. No. siehe Seite 2.21]

Basic luminaire set with parabolic louvre.
[Art. No. please see page 2.21]

Jeu d'éclairage de base avec grille parabolique.
[Art. No. voir page 2.21 s.v.p.]

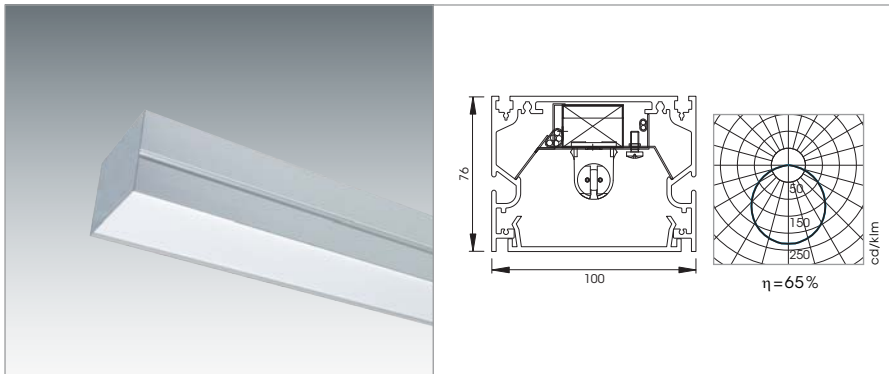

Leuchteneinsatz mit satiniertes Abdeckung.
[Art. No. siehe Seite 2.21]

Basic luminaire set with satinised diffuser.
[Art. No. please see page 2.21]

Jeu d'éclairage de base avec diffuseur dépoli.
[Art. No. voir page 2.21 s.v.p.]

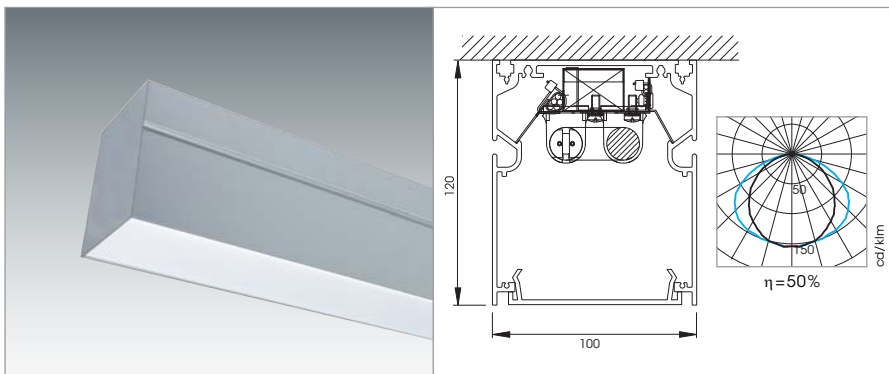

Alternativ: Leuchteneinsatz mit satiniertes Abdeckung für OM 76H zum Erzielen einer gleichmäßigen Ausleuchtung.
[Art. No. siehe Seite 2.21]

Alternative: Luminaire set with satinised diffuser for OM 76H to achieve a uniform illumination.
[Art. No. please see page 2.21]

Alternative: Jeu d'éclairage de base avec diffuseur dépoli pour OM 76H pour obtenir un éclairage uniforme.
[Art. No. voir page 2.21 s.v.p.]

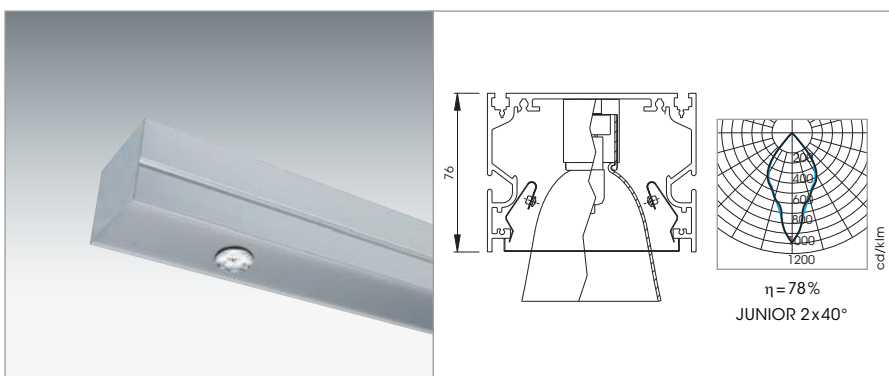

Downlight 20-35W / 12V mit elektronischem Vorschaltgerät. [Art. No. siehe Seite 2.21]

20-35W / 12V Downlight with electronic series unit.
[Art. No. please see page 2.21]

Downlight 20-35W / 12V avec ballast électronique.
[Art. No. voir page 2.21 s.v.p.]

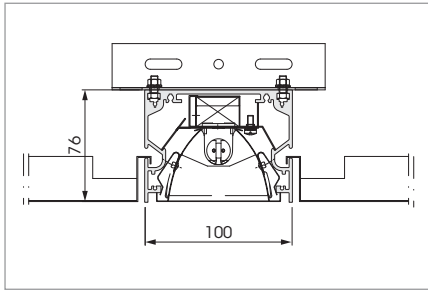

Als Decken-Unterkonstruktion:
OMEGA 76 als Trageprofil zu Langfeldplattensystemen. Homogene Verbindung von Leuchte und Decke durch Profilform.

Serving as ceiling suspension:
OMEGA 76 used as carrier for rectangular panel systems. A homogenous combination of luminaire and ceiling through the profile form.

*Comme ossature pour plafonds suspendus:
OMEGA 76 utilisé comme élément porteur pour des systèmes de panneaux rectangulaires. Une combinaison homogène de luminaire et plafond par la forme du profilé.*

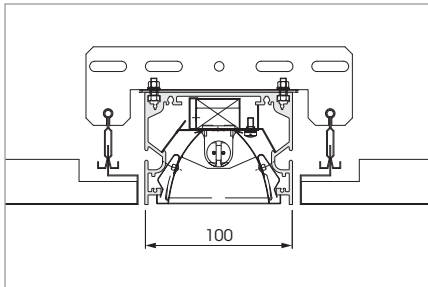

Einbau mit Fuge:
Einsetzbar für Klemm- und Klapp-Metaldeckensysteme.

Shadow gap installation:
Suitable for clip-in and hingeable suspended metal ceiling systems.

*Installation avec joint creux:
Utilisable pour des systèmes de plafonds métalliques à clipser et basculables.*

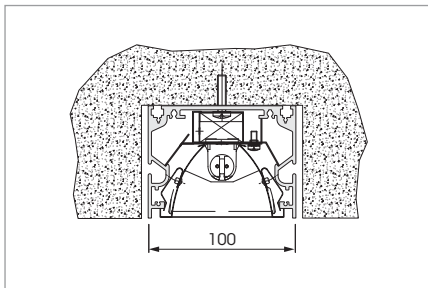

Betondecken-Einbau.

Installation in concrete slab.

Installation en dalles de béton.

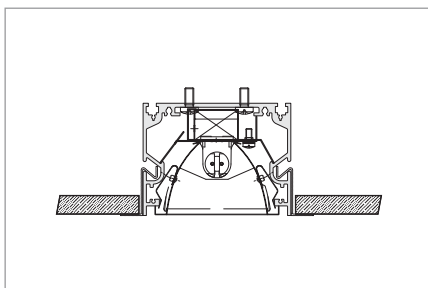

Einbau mit Rahmen für Gipskarton-Decke.

Installation with frame for gypsum board ceilings.

Installation avec encadrement pour des plafonds à plaque au plâtre.

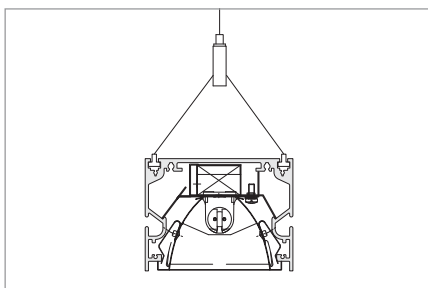

Abgehängte Lichtbandversion.

Suspended batten light version.

Version type réglette suspendue.

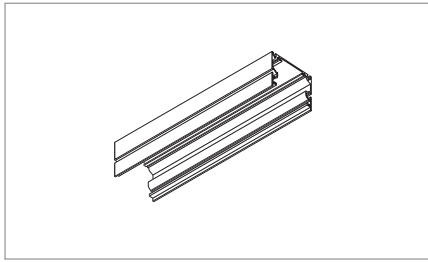

Aluminium Leerkanal.

Aluminium base channel, empty.

Tube de base vide en aluminium.

Art. No.	H [mm]	B [mm]	L [mm]
OM76-6000	76	100	6000

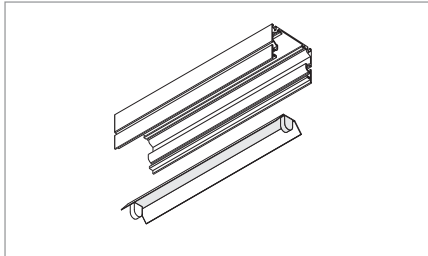

Leuchteneinsatz mit EVG.

Light unit with electronic ballast.

Unité d'éclairage avec ballast électronique.

Art. No.		L [mm]
OM76-1139-001	1 x 39W T5	895
OM76-1154-001	1 x 54W T5	1195
OM76-1180-001	1 x 80W T5	1495

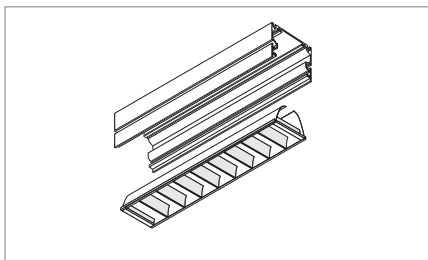

Parabolraster BAP.

Parabolic LG 3 class II louvre.

Grille parabolique anti-éblouissante.

Art. No.		L [mm]
OM76-P1199	1 x 54W T5	1199
OM76-P1499	1 x 80W T5	1499

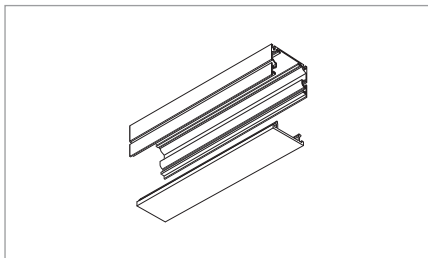

Satinierte Abdeckung zu Leuchteneinsatz.

Satinised diffuser for basic luminaire set.

Diffuseur dépoli pour jeu d'éclairage de base.

Art. No.		L [mm]
OM76-WS4000		4000

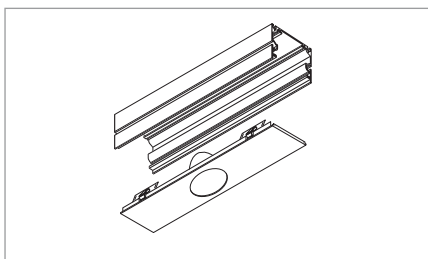

Downlight mit Abdeckung.

Downlight with cover plate.

Downlight avec plaque de fermeture

Art. No.		L [mm]
Downlight	Downlight	Downlight
OM76-Junior	1 x 20-35W / 12V Qi12-ax	

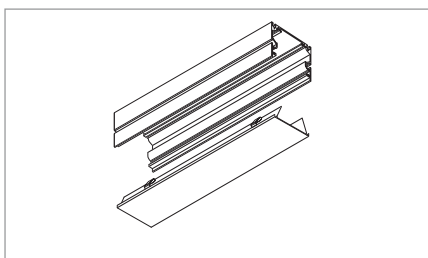

Blindabdeckung [Länge auf Anfrage, max. 1 m].

Cover plate [Length upon request, max. 1 m].

Cache [Longueur à commander, max. 1 m].

Art. No.
OM76-Z009

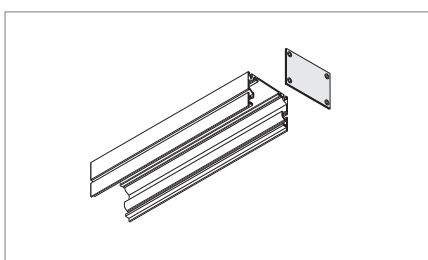

Stirnteil.

Front cover plate.

Panneau frontale.

Art. No.
OM76-Z008

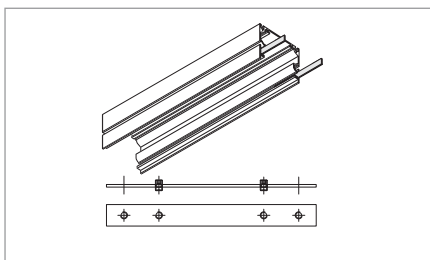

Längsverbinder.

Longitudinal connector.

Raccord longitudinal.

Art. No.

OM76-Z004

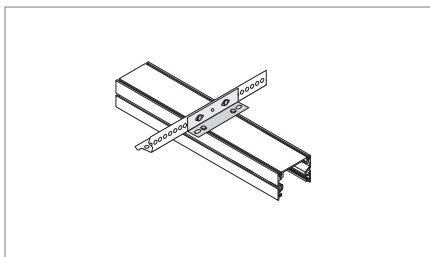

Abhänger zu Rostwinkel U 1040 bzw. Gewindestab.

Hanger for secondary carrier U 1040 or threaded rod.

Suspension pour porteur secondaire U 1040 ou tige filetée.

Art. No.

OM76-Z001

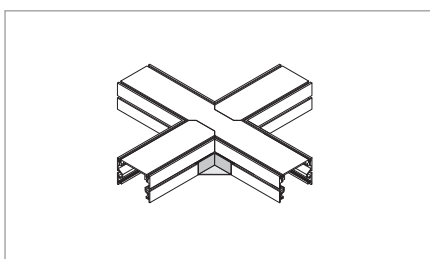

Eckwinkel zum Einhängen.

Hook-on corner bracket.

Cornière pour accrochage.

Art. No.

OM76-Z002

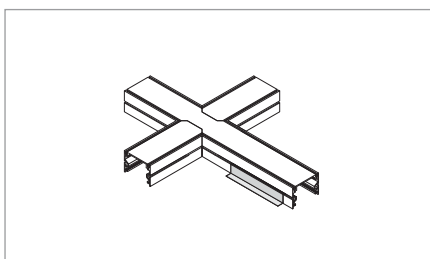

Kaschierung.

Cover.

Cache.

Art. No.

OM76-Z003

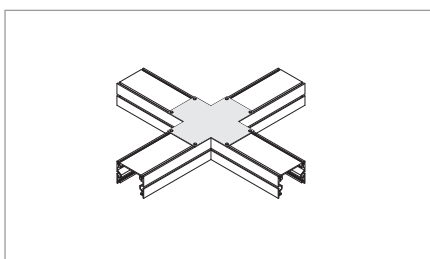

Kreuz-Verbinder.

Cross-connector.

Raccord croisé.

Art. No.

OM76-Z007

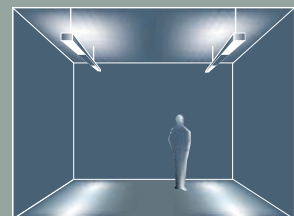
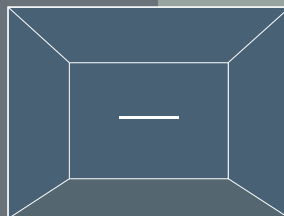
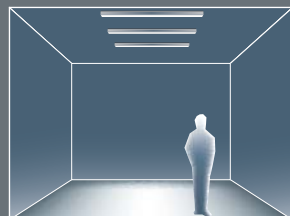
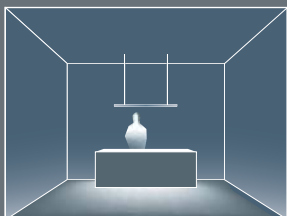

CAMPUS



Direkt strahlende Aluminium-Profil-Pendelleuchte, silber RAL 9006. Spiegelrastrer Aluminium hochglanz, rundum entblendet, BAP-gerecht. Anbauversion auf Anfrage.

Suspended aluminium profile luminaire with direct beam pattern, silver RAL 9006. Mirror louvre highly polished aluminium, shaded all around according LG3 class II categorisation. Surface mounted version upon request.

Luminaire suspendu de rayonnement directe en profilé d'aluminium extrudé, argenté RAL 9006. Ecran miroité en aluminium brillant, en version anti-aveuglement de tous les côtés, conforme aux règles pour lieux de travail à écran. Version apparente sur demande.

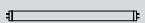
Art. No.		A [mm]	L [mm]
camp-1128-K20	1 x 28W T5	800	1200
camp-1154-K20	1 x 54W T5	800	1200
camp-1135-K20	1 x 35W T5	1200	1500
camp-1180-K20	1 x 80W T5	1200	1500

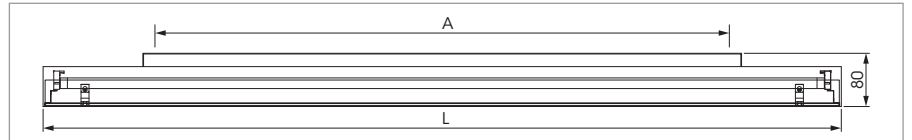

Direkt strahlende Aluminium-Profil-Pendelleuchte, silber RAL 9006. Mit Prismenscheiben-Abdeckung und Aluminium-Reflektor. Anbauversion auf Anfrage.

Suspended aluminium profile luminaire with direct beam pattern, silver RAL 9006, with prismatic diffuser and aluminium reflector. Surface mounted version upon request.

Luminaire suspendu de rayonnement directe en profilé d'aluminium extrudé, argenté RAL 9006. Equipé d'un diffuseur prismatique et réflecteur en aluminium. Version apparente sur demande.

Art. No.		A [mm]	L [mm]
camp-1128-K22	1 x 28W T5	800	1200
camp-1154-K22	1 x 54W T5	800	1200
camp-1135-K22	1 x 35W T5	1200	1500
camp-1180-K22	1 x 80W T5	1200	1500

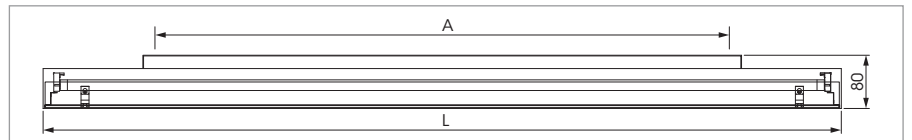

ZUBEHÖR ACCESSORIES ACCESSOIRES

Stahlseil [pro Leuchte 2 Stück bestellen].
Steel wire [2 pieces per luminaire to be ordered].
Suspension à câble d'acier [2 pièces par luminaire à commander].

Deckenhalter [pro Leuchte 2 Stück bestellen].
Ceiling plate [2 pieces per luminaire to be ordered].
Rosace [2 pièces par luminaire à commander].

Art. No.	L [mm]
OK3-1000	1000

Art. No.
OK4EA

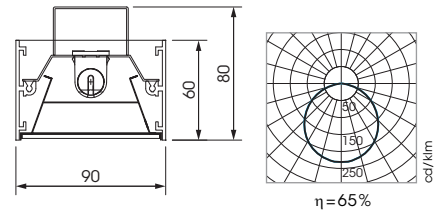

Direkt strahlende Aluminium-Profil-Pendelleuchte, silber RAL 9006. Mit Opalglas-Abdeckung und Aluminium-Reflektor.
Anbauversion auf Anfrage.

Suspended aluminium profile luminaire with direct beam pattern, silver RAL 9006, with opal glass diffuser and aluminium reflector.
Surface mounted version upon request.

*Luminaire suspendu directe en profilé d'aluminium extrudé, argenté RAL 9006. Equipé d'un diffuseur opale et réflecteur en aluminium.
Version apparente sur demande.*

Art. No.		A [mm]	L [mm]
camp-1128-K21	1 x 28W T5	800	1200
camp-1154-K21	1 x 54W T5	800	1200
camp-1135-K21	1 x 35W T5	1200	1500
camp-1180-K21	1 x 80W T5	1200	1500

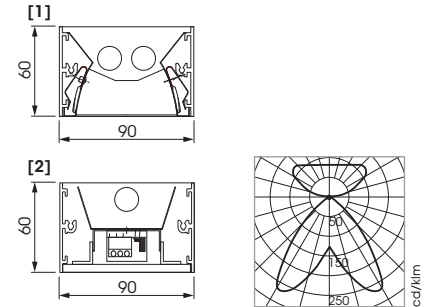
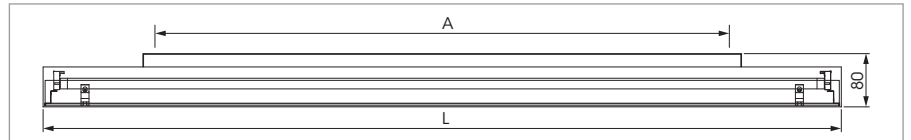

Aluminium-Profil-Pendelleuchte, weiß. Die Enden der Leuchte direkt/indirekt strahlend [1] über Spiegelraster Aluminium hochglanz, rundum entblendet, BAP-gerecht. Bestückt mit 2x2x24W T5 Lampen. [2] Der Mittelteil rein indirekt strahlend [Rohrpendel bitte separat bestellen, siehe Seite 4.22].

Suspended aluminium profile luminaire, white. Direct/indirect beam pattern at both ends [1] of the luminaire, provided through a highly polished aluminium louvre, shaded all around according LG3 class II categorisation. Equipped with 2x2x24W T5 lamps.[2] The centre part is indirect beaming [suspension tubes, please order separately, see page 4.22].

Luminaire suspendu directe en profilé en aluminium extrudé, blanc. Les bouts du luminaire ont un rayonnement direct/indirect [1] par un réflecteur miroité en aluminium brillant, en version anti-aveuglement de tous les cotés conforme aux règles pour lieux de travail à écran. Equipé de lampes 2x2x24W T5. [2] La partie centrale est indirecte [les tube de suspension sont à commander séparément, s.v.p. voir page 4.22].

Art. No.		A [mm]	L [mm]	B [mm]	H [mm]
camp-1180-K30	1 x 80W + 2x2x24W T5	1540	2850	90	60

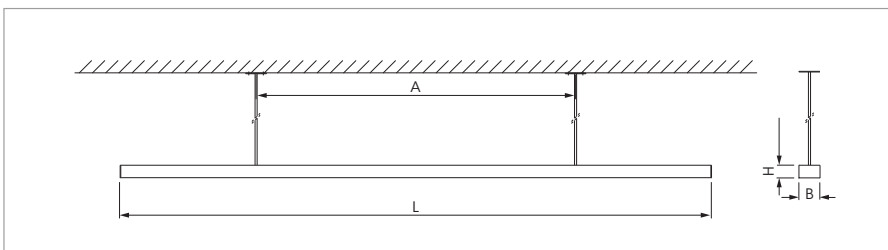

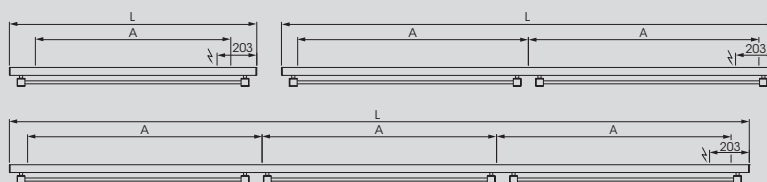

A... Befestigungsabstand für Deckenmontage
Seilaufhängung und
Befestigungsflansch variabel

A... Distance for ceiling mounting
variable for cable suspension
and flange fitting

A... Distance pour fixation au plafond
variable pour suspension
à fils et bride de fixation

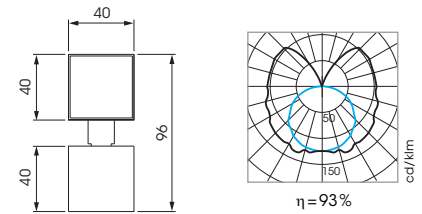
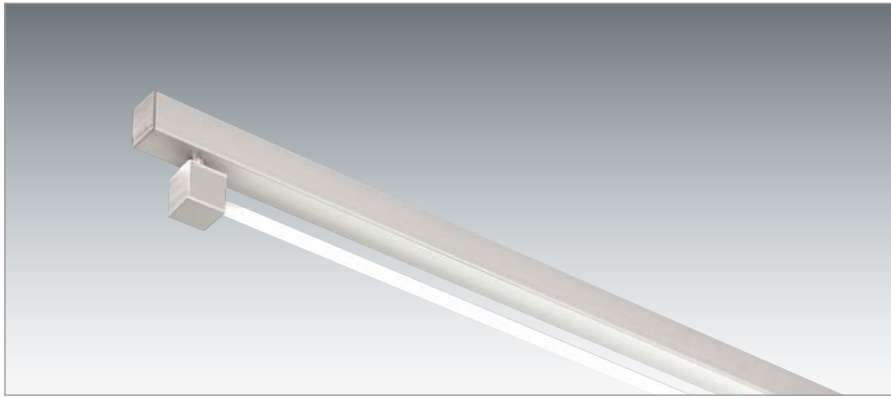

Freistrahkende, offene Anbau- und Pendelleuchte, Alu-Profil 40x40mm und Fassungshalterung farblos eloxiert. Die 2- und 3-längigen Leuchten enthalten eine Durchgangsverdrahtung 5x1,5mm².

Surface mounted or pendant luminaire, aluminium profile 40x40mm and lampholder boxes natural anodized. The dual- and triple-length luminaires are equipped with a preassembled wiring 5x1,5mm².

Luminaire à rayonnement libre apparent et à suspensions, profilé en aluminium anodisé nature 40x40mm et boîtes de douille en aluminium anodisé nature. La version duo et triple est préalablement câblée 5x1,5mm².

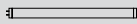
Art. No.		A [mm]	L [mm]
1-längig single-length mono longueur			
4510-1287	1x28W T5	1000	1266
4510-1547	1x54W T5	1000	1266
4510-1357	1x35W T5	1300	1566
4510-1807	1x80W T5	1300	1566

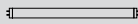
Art. No.		A [mm]	L [mm]
2-längig dual-length duo longueur			
4520-2287	2x1x28W T5	1180	2526
4520-2547	2x1x54W T5	1180	2526
4520-2357	2x1x35W T5	1480	3126
4520-2807	2x1x80W T5	1480	3126

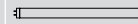
Art. No.		A [mm]	L [mm]
3-längig triple-length triple longueur			
4530-3287	3x1x28W T5	1200	3786
4530-3547	3x1x54W T5	1200	3786
4530-3357	3x1x35W T5	1500	4686
4530-3807	3x1x80W T5	1500	4686

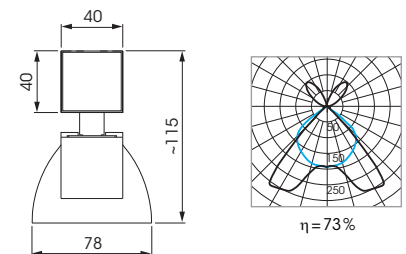
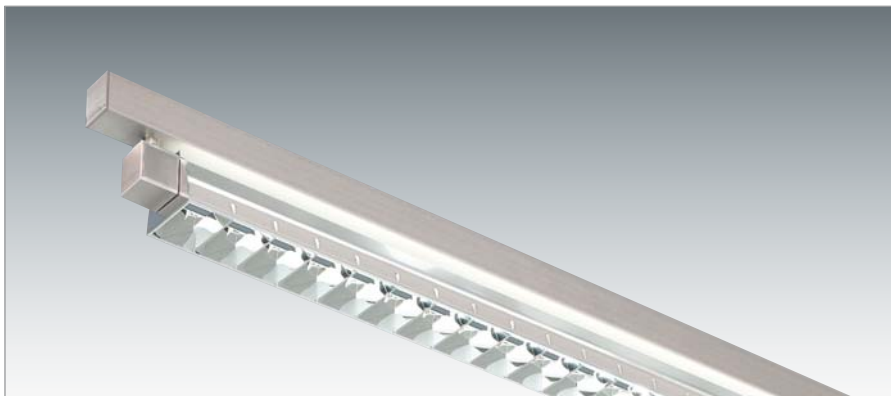

Direkt/indirekt strahlende Spiegelraster-Anbau- und Pendelleuchte, Alu-Profil 40x40mm und Fassungshalterung farblos eloxiert. Die 2- und 3-längigen Leuchten enthalten eine Durchgangsverdrahtung 5x1,5mm². Spiegelraster Aluminium hochglanz, rundum entblendet.

Surface mounted or pendant direct/indirect luminaire with mirror louvre, aluminium profile 40x40mm and lampholder boxes natural anodized. The dual- and triple-length luminaires are equipped with a pre-assembled wiring 5x1,5mm². Mirror louvre, highly polished aluminium, glare free.

Luminaire à écran miroité apparent et à suspensions pour éclairage direct/indirect. Profilé en aluminium anodisé nature 40x40mm et boîtes de douille en aluminium anodisé nature. La version duo et triple est préalablement câblée 5x1,5mm². Ecran en aluminium miroité poli brillant, non-éblouissant de toutes les directions.

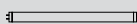
Art. No.		A [mm]	L [mm]
1-längig single-length mono longueur			
4512HB-1287	1x28W T5	1000	1266
4512HB-1547	1x54W T5	1000	1266
4512HB-1357	1x35W T5	1300	1566
4512HB-1807	1x80W T5	1300	1566

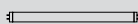
Art. No.		A [mm]	L [mm]
2-längig dual-length duo longueur			
4522HB-2287	2x1x28W T5	1180	2526
4522HB-2547	2x1x54W T5	1180	2526
4522HB-2357	2x1x35W T5	1480	3126
4522HB-2807	2x1x80W T5	1480	3126

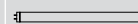
Art. No.		A [mm]	L [mm]
3-längig triple-length triple longueur			
4532HB-3287	3x1x28W T5	1200	3786
4532HB-3547	3x1x54W T5	1200	3786
4532HB-3357	3x1x35W T5	1500	4686
4532HB-3807	3x1x80W T5	1500	4686

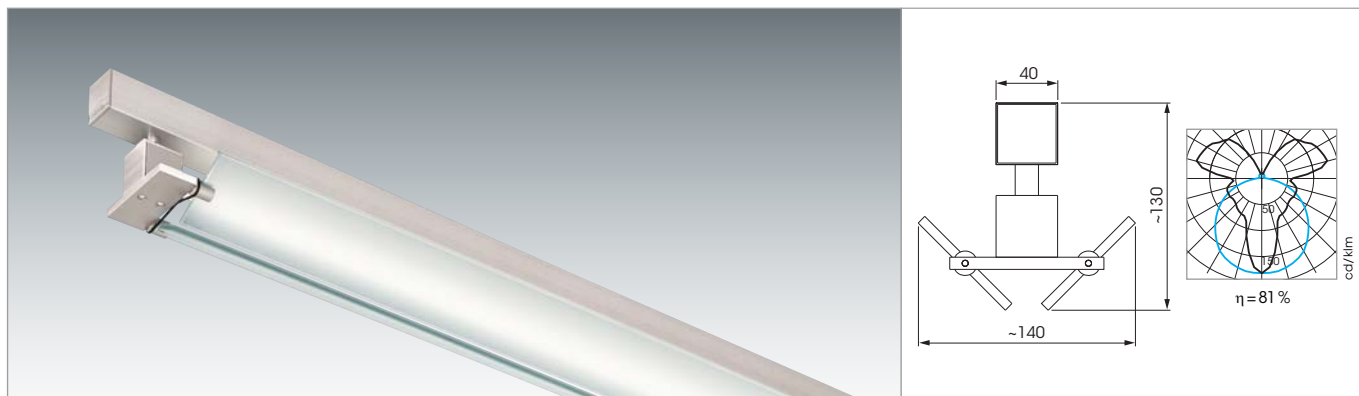

Anbau- und Pendelleuchte, Alu-Profil 40x40mm und Fassungshalterung farblos eloxiert. Die 2- und 3-längigen Leuchten enthalten eine Durchgangsverdrahtung 5x1,5mm².

Mit zwei Glasscheiben sandmattiert, drehbar [nicht lieferbar für 35/80W].

Surface mounted or pendant luminaire, aluminium profile 40x40mm and lampholder boxes natural anodized. The dual- and triple-length luminaires are equipped with a preassembled wiring 5x1,5mm².

With two pivoting opal diffusor glass blades [not available for 35/80W].

Luminaire apparent et à suspensions, profilé en aluminium anodisé nature 40x40mm et boîtes de douille en aluminium anodisé nature. La version duo et triple est préalablement câblée 5x1,5mm².

Avec deux verres satinés, pivotants [pas livrable pour 35/80W].

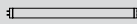
Art. No.		A [mm]	L [mm]
1-längig single-length mono longueur			
4511GS-1287	1x28W T5	1000	1266
4511GS-1547	1x54W T5	1000	1266

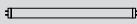
Art. No.		A [mm]	L [mm]
2-längig dual-length duo longueur			
4521GS-2287	2x1x28W T5	1180	2526
4521GS-2547	2x1x54W T5	1180	2526

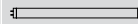
Art. No.		A [mm]	L [mm]
3-längig triple-length triple longueur			
4531GS-3287	3x1x28W T5	1200	3786
4531GS-3547	3x1x54W T5	1200	3786

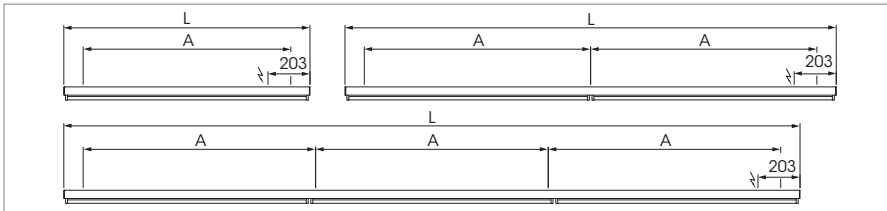

A... Befestigungsabstand für Deckenmontage
Seilaufhängung und Befestigungsflansch
variabel

A... Distance for ceiling mounting
variable for cable suspension and flange fitting

A... Distance pour fixation au plafond
variable pour suspension à fils et bride de
fixation

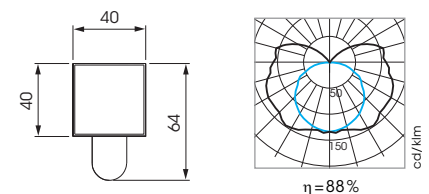
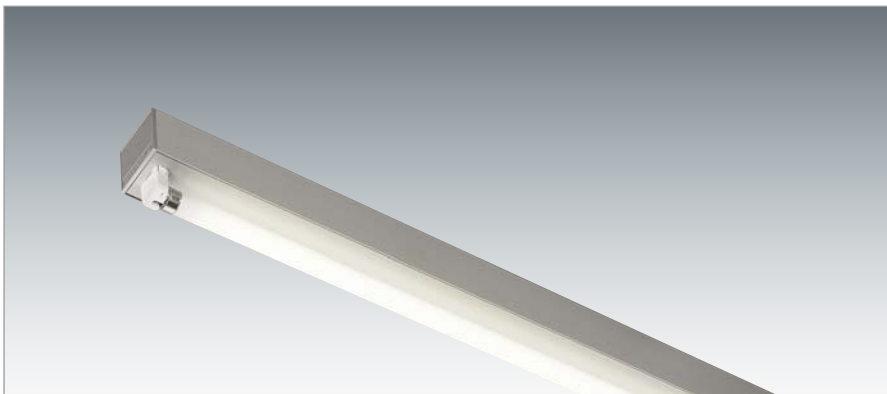

Freistrahkende, offene Anbau- und Pendelleuchte, Alu-Profil 40x40mm farblos eloxiert. Die 2- und 3-längigen Leuchten enthalten eine Durchgangsverdrahtung 5x1,5mm².

Surface mounted or pendant luminaire, aluminium profile 40x40mm natural anodized. The dual- und triple length luminaires are equipped with a preassembled wiring 5x1.5mm².

Luminaire à rayonnement libre apparent et à suspensions, profilé en aluminium anodisé nature 40x40mm. La version duo et triple est préalablement câblée 5x1,5mm².

Art. No.		A [mm]	L [mm]
1-längig single-length mono longueur			
4560-1287	1x28W T5	1000	1186
4560-1547	1x54W T5	1000	1186
4560-1357	1x35W T5	1300	1486
4560-1807	1x80W T5	1300	1486

Art. No.		A [mm]	L [mm]
2-längig dual-length duo longueur			
4570-2287	2x1x28W T5	1090	2366
4570-2547	2x1x54W T5	1090	2366
4570-2357	2x1x35W T5	1390	2966
4570-2807	2x1x80W T5	1390	2966

Art. No.		A [mm]	L [mm]
3-längig triple-length triple longueur			
4580-3287	3x1x28W T5	1120	3546
4580-3547	3x1x54W T5	1120	3546
4580-3357	3x1x35W T5	1420	4446
4580-3807	3x1x80W T5	1420	4446

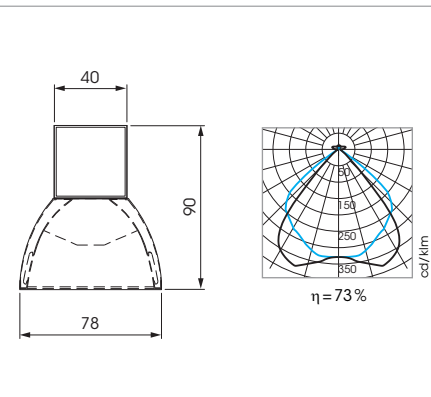
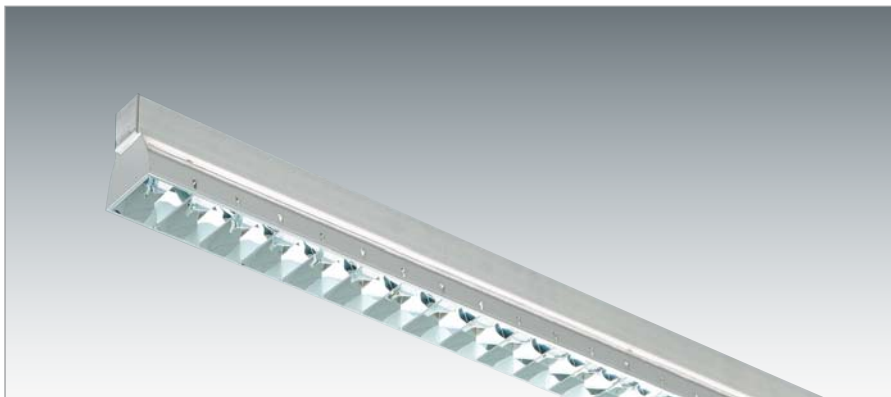



Direkt/indirekt strahlende Spiegelraster-Anbau- und Pendelleuchte, Alu-Profil 40x40mm farblos eloxiert. Die 2- und 3-längigen Leuchten enthalten eine Durchgangsverdrahtung 5x1,5mm². Spiegelraster Aluminium hochglanz, rundum entblendet, direkt/indirekt strahlend.

Surface mounted or pendant direct/indirect luminaire with mirror louvre, aluminium profile 40x40mm natural anodized. The dual- and triple-length luminaires are equipped with a preassembled wiring 5x1,5mm². Mirror louvre direct/indirect illumination, highly polished aluminium, glare free.

Luminaire à écran miroité apparent et à suspensions pour éclairage direct/indirect. Profilé en aluminium anodisé nature 40x40mm. La version duo et triple est préalablement câblée 5x1,5mm². Ecran en aluminium miroité poli brillant, non-éblouissant de toutes les directions, éclairage direct/indirect.

Art. No.		A [mm]	L [mm]
1-längig	single-length	mono longueur	
4562DI-1287	1 x 28W T5	1000	1186
4562DI-1547	1 x 54W T5	1000	1186
4562DI-1357	1 x 35W T5	1300	1486
4562DI-1807	1 x 80W T5	1300	1486

Art. No.		A [mm]	L [mm]
2-längig	dual-length	duo longueur	
4572DI-2287	2 x 1 x 28W T5	1090	2366
4572DI-2547	2 x 1 x 54W T5	1090	2366
4572DI-2357	2 x 1 x 35W T5	1390	2966
4572DI-2807	2 x 1 x 80W T5	1390	2966

Art. No.		A [mm]	L [mm]
3-längig	triple-length	triple longueur	
4582DI-3287	3 x 1 x 28W T5	1120	3546
4582DI-3547	3 x 1 x 54W T5	1120	3546
4582DI-3357	3 x 1 x 35W T5	1420	4446
4582DI-3807	3 x 1 x 80W T5	1420	4446

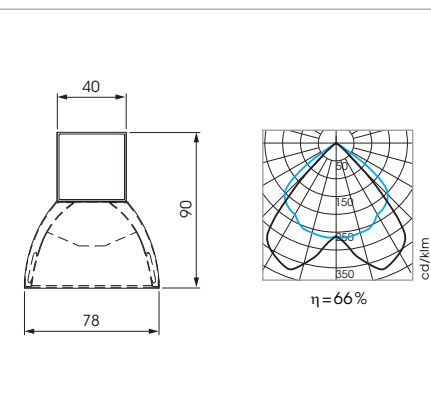
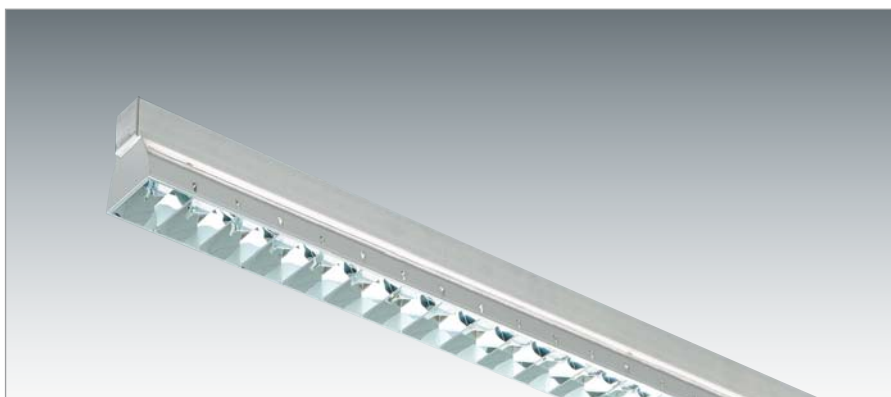



Direkt strahlende Spiegelraster-Anbau- und Pendelleuchte, Alu-Profil 40x40mm farblos eloxiert. Die 2- und 3-längigen Leuchten enthalten eine Durchgangsverdrahtung 5x1,5mm². Spiegelraster Aluminium hochglanz, rundum entblendet, direkt strahlend.

Surface mounted or pendant direct luminaire with mirror louvre, aluminium profile 40x40mm natural anodized. The dual- and triple-length luminaires are equipped with a preassembled wiring 5x1,5mm². Mirror louvre direct illumination, highly polished aluminium, glare free.

Luminaire à écran miroité apparent et à suspensions pour éclairage direct. Profilé en aluminium anodisé nature 40x40mm. La version duo et triple est préalablement câblée 5x1,5mm². Ecran en aluminium miroité poli brillant, non-éblouissant de toutes les directions, éclairage direct.

Art. No.		A [mm]	L [mm]
1-längig	single-length	mono longueur	
4562DD-1287	1 x 28W T5	1000	1186
4562DD-1547	1 x 54W T5	1000	1186
4562DD-1357	1 x 35W T5	1300	1486
4562DD-1807	1 x 80W T5	1300	1486

Art. No.		A [mm]	L [mm]
2-längig	dual-length	duo longueur	
4572DD-2287	2 x 1 x 28W T5	1090	2366
4572DD-2547	2 x 1 x 54W T5	1090	2366
4572DD-2357	2 x 1 x 35W T5	1390	2966
4572DD-2807	2 x 1 x 80W T5	1390	2966

Art. No.		A [mm]	L [mm]
3-längig	triple-length	triple longueur	
4582DD-3287	3 x 1 x 28W T5	1120	3546
4582DD-3547	3 x 1 x 54W T5	1120	3546
4582DD-3357	3 x 1 x 35W T5	1420	4446
4582DD-3807	3 x 1 x 80W T5	1420	4446



Anbau- und Pendelleuchte, Alu-Profil 40x40mm farblos eloxiert. Die 2- und 3-längigen Leuchten enthalten eine Durchgangsverdrahtung 5x1,5mm². Acrylglasabdeckung satiné rund.

Surface mounted or pendant luminaire, aluminium profile 40x40mm natural anodized. The dual- and triple-length luminaires are equipped with a preassembled wiring 5x1.5mm². Circular acrylic diffuser, opal satiné.

Luminaire apparent et à suspensions, profilé en aluminium anodisé nature 40x40mm. La version duo et triple est préalablement câblée 5x1,5mm². Diffuseur rond en verre acrylique satiné.

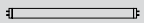
Art. No.		A [mm]	L [mm]
1-längig single-length mono longueur			
4563GS-1147	1 x 14W T5	500	586
4563GS-1247	1 x 24W T5	500	586
4563GS-1217	1 x 21W T5	700	886
4563GS-1397	1 x 39W T5	700	886
4563GS-1287	1 x 28W T5	1000	1186
4563GS-1547	1 x 54W T5	1000	1186
4563GS-1357	1 x 35W T5	1300	1486
4563GS-1807	1 x 80W T5	1300	1486

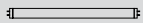
Art. No.		A [mm]	L [mm]
2-längig dual-length duo longueur			
4573GS-2287	2 x 1 x 28W T5	1090	2366
4573GS-2547	2 x 1 x 54W T5	1090	2366
4573GS-2357	2 x 1 x 35W T5	1390	2966
4573GS-2807	2 x 1 x 80W T5	1390	2966

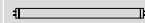
Art. No.		A [mm]	L [mm]
3-längig triple-length triple longueur			
4583GS-3287	3 x 1 x 28W T5	1120	3546
4583GS-3547	3 x 1 x 54W T5	1120	3546
4583GS-3357	3 x 1 x 35W T5	1420	4446
4583GS-3807	3 x 1 x 80W T5	1420	4446





Anbau- und Pendelleuchte, Alu-Profil 40x40mm farblos eloxiert. Die 2- und 3-längigen Leuchten enthalten eine Durchgangsverdrahtung 5x1,5mm². Acrylglasabdeckung satiné quadratisch.

Surface mounted or pendant luminaire, aluminium profile 40x40mm natural anodized. The dual- and triple-length luminaires are equipped with a preassembled wiring 5x1.5mm². Square acrylic diffuser, opal satiné.

Luminaire apparent et à suspensions, profilé en aluminium anodisé nature 40x40mm. La version duo et triple est préalablement câblée 5x1,5mm². Diffuseur carré en verre acrylique satiné.

Art. No.		A [mm]	L [mm]
1-längig single-length mono longueur			
4563GQ-1147	1 x 14W T5	500	586
4563GQ-1247	1 x 24W T5	500	586
4563GQ-1217	1 x 21W T5	700	886
4563GQ-1397	1 x 39W T5	700	886
4563GQ-1287	1 x 28W T5	1000	1186
4563GQ-1547	1 x 54W T5	1000	1186
4563GQ-1357	1 x 35W T5	1300	1486
4563GQ-1807	1 x 80W T5	1300	1486

Art. No.		A [mm]	L [mm]
2-längig dual-length duo longueur			
4573GQ-2287	2 x 1 x 28W T5	1090	2366
4573GQ-2547	2 x 1 x 54W T5	1090	2366
4573GQ-2357	2 x 1 x 35W T5	1390	2966
4573GQ-2807	2 x 1 x 80W T5	1390	2966

Art. No.		A [mm]	L [mm]
3-längig triple-length triple longueur			
4583GQ-3287	3 x 1 x 28W T5	1120	3546
4583GQ-3547	3 x 1 x 54W T5	1120	3546
4583GQ-3357	3 x 1 x 35W T5	1420	4446
4583GQ-3807	3 x 1 x 80W T5	1420	4446

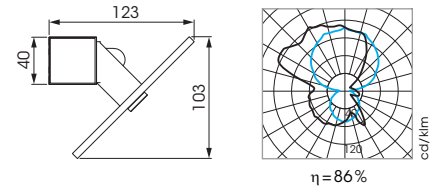
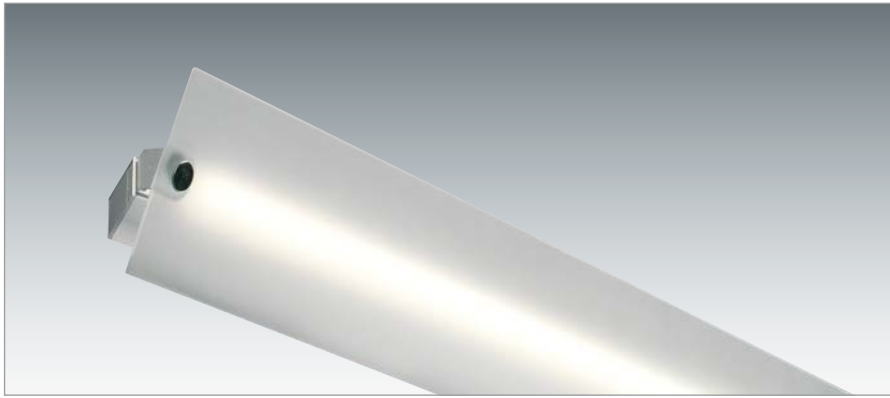

Wandleuchte, Alu-Profil 40x40mm farblos eloxiert.
Glasscheibe sandmattiert.

Wall mounted luminaire, aluminium profile 40x40mm
natural anodized.
Opal diffuser glass blade.

Applique, profilé en aluminium anodisé nature
40x40mm.
Verre satiné.

Art. No.		A [mm]	L [mm]
4566G-1147	1 x 14W T5	500	606
4566G-1247	1 x 24W T5	500	606

Art. No.		A [mm]	L [mm]
4566G-1217	1 x 21W T5	700	906
4566G-1397	1 x 39W T5	700	906

Art. No.		A [mm]	L [mm]
4566G-1287	1 x 28W T5	1000	1206
4566G-1547	1 x 54W T5	1000	1206

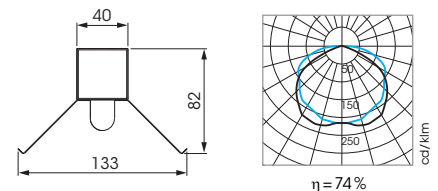

Reflektor-Anbau- und Pendelleuchte, Alu-Profil 40x40mm farblos eloxiert. Die 2- und 3-längigen Leuchten enthalten eine Durchgangsverdrahtung 5x1,5mm². Reflektor Aluminium matt.

Surface mounted or pendant reflector luminaire, aluminium profile 40x40mm natural anodized. The dual- and triple-length luminaires are equipped with a pre-assembled wiring 5x1,5mm². Reflector, aluminium matt.

Luminaire à réflecteur apparent et à suspensions, profilé en aluminium anodisé nature 40x40mm. La version duo et triple est préalablement câblée 5x1,5mm². Réflecteur en aluminium mat.

Art. No.		A [mm]	L [mm]
1-längig single-length <i>mono longueur</i>			
4561RS-1287	1 x 28W T5	1000	1186
4561RS-1547	1 x 54W T5	1000	1186
4561RS-1357	1 x 35W T5	1300	1486
4561RS-1807	1 x 80W T5	1300	1486

Art. No.		A [mm]	L [mm]
2-längig dual-length <i>duo longueur</i>			
4571RS-2287	2 x 1 x 28W T5	1090	2366
4571RS-2547	2 x 1 x 54W T5	1090	2366
4571RS-2357	2 x 1 x 35W T5	1390	2966
4571RS-2807	2 x 1 x 80W T5	1390	2966

Art. No.		A [mm]	L [mm]
3-längig triple-length <i>triple longueur</i>			
4581RS-3287	3 x 1 x 28W T5	1120	3546
4581RS-3547	3 x 1 x 54W T5	1120	3546
4581RS-3357	3 x 1 x 35W T5	1420	4446
4581RS-3807	3 x 1 x 80W T5	1420	4446

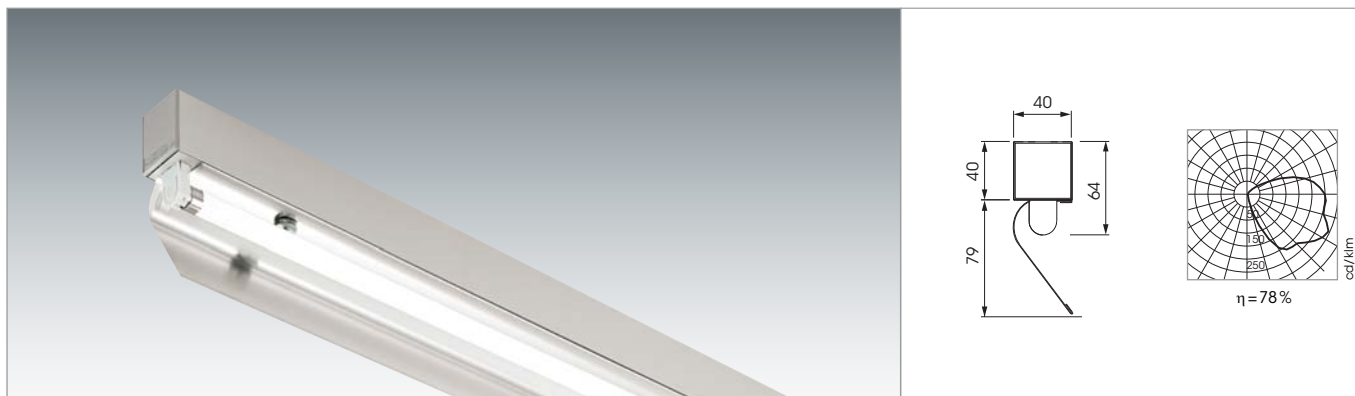



Anbau- und Pendelleuchte, Alu-Profil 40x40mm farblos eloxiert. Die 2- und 3-längigen Leuchten enthalten eine Durchgangsverdrahtung 5x1,5mm². Reflektor asymmetrisch, Aluminium matt.

Surface mounted or pendant luminaire, aluminium profile 40x40mm natural anodized. The dual- and triple-length luminaires are equipped with a preassembled wiring 5x1.5mm². Asymmetrical reflector, aluminium matt.

Luminaire apparent et à suspensions, profilé en aluminium anodisé nature 40x40mm. La version duo et triple est préalablement câblée 5x1,5mm². Réflecteur asymétrique, en aluminium mat.

Art. No.		A [mm]	L [mm]
1-längig single-length mono longueur			
4561RA-1287	1x28W T5	1000	1186
4561RA-1547	1x54W T5	1000	1186
4561RA-1357	1x35W T5	1300	1486
4561RA-1807	1x80W T5	1300	1486

Art. No.		A [mm]	L [mm]
2-längig dual-length duo longueur			
4571RA-2287	2x1x28W T5	1090	2366
4571RA-2547	2x1x54W T5	1090	2366
4571RA-2357	2x1x35W T5	1390	2966
4571RA-2807	2x1x80W T5	1390	2966

Art. No.		A [mm]	L [mm]
3-längig triple-length triple longueur			
4581RA-3287	3x1x28W T5	1120	3546
4581RA-3547	3x1x54W T5	1120	3546
4581RA-3357	3x1x35W T5	1420	4446
4581RA-3807	3x1x80W T5	1420	4446

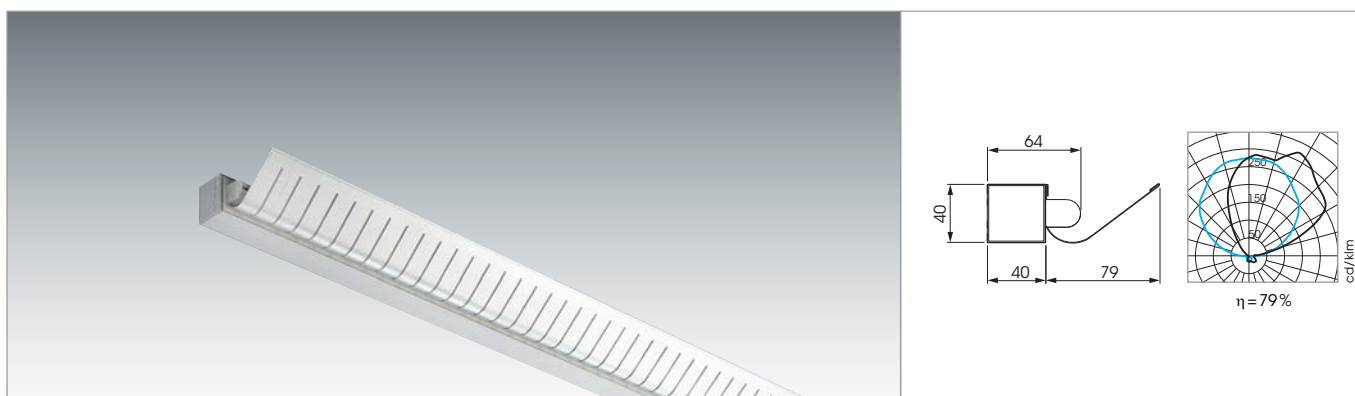

Wandleuchte, Alu-Profil 40x40mm farblos eloxiert. Reflektor asymmetrisch, Aluminium matt, indirekt strahlend mit Direktanteil.

Wall mounted luminaire, aluminium profile 40x40mm natural anodized. Asymmetrical reflector, aluminium matt, indirect/partially direct illumination.

Applique, profilé en aluminium anodisé nature 40x40mm. Réflecteur asymétrique, en aluminium mat, éclairage indirect/partiellement direct.

Art. No.		A [mm]	L [mm]
4561WA-1247	1x24W T5	500	586
4561WA-1397	1x39W T5	700	886
4561WA-1547	1x54W T5	1000	1186
4561WA-1807	1x80W T5	1300	1486

TALILUX®-E



Pendelleuchte Alu-Profil 40x40mm farblos eloxiert.
Leuchtkörper abgehängt, Acrylglas satiné.

Suspended luminaire, ceiling rail aluminium profile
40x40mm, natural anodized.
Opal acrylic body, suspended.

*Pendentif profilé en aluminium anodisé nature
40x40mm.
Corps suspendu, verre acrylique satiné.*

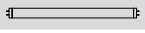
Art. No.		A [mm]	L [mm]
4564GS-2287	2x28W T5	1000	1166
4564GS-2547	2x54W T5	1000	1166
4564GS-2357	2x35W T5	1300	1466
4564GS-2807	2x80W T5	1300	1466

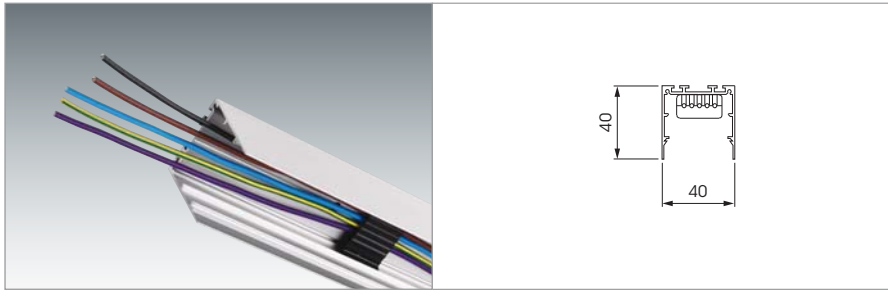

Aluminium-Profiltschiene 40x40mm, farblos eloxiert, mit Durchgangsverdrahtung 5x1,5mm². Sonderlängen auf Anfrage.

Aluminium base profile 40x40mm, natural anodized, with preassembled wiring 5x1,5mm². Customised lengths on request.

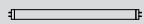
Art. No.		L [mm]
4500-A37	2x28 / 54W T5	2360
4500-A57	3x28 / 54W T5	3540
4500-A47	2x35 / 80W T5	2960
4500-A67	3x35 / 80W T5	4440

Profilé en aluminium anodisé nature 40x40mm, avec pré-câblage 5x1,5mm². Longueurs spéciales sur demande.



Aluminium-Profiltschiene 40x40mm, farblos eloxiert, ohne Durchgangsverdrahtung. Sonderlängen auf Anfrage.

Aluminium base profile 40x40mm, natural anodized, without preassembled wiring. Customised lengths on request.

Art. No.		L [mm]
4500-A01		6300
4500-A16	1x28/54W T5	1180
4500-A26	1x35/80W T5	1480

Profilé en aluminium anodisé nature 40x40mm, sans pré-câblage. Longueurs spéciales sur demande.

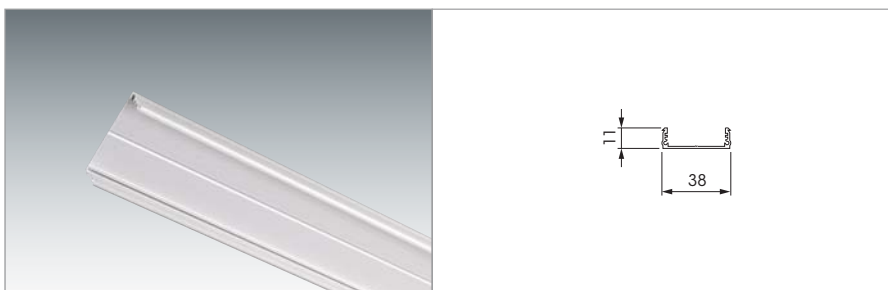

Blindabdeckung, Aluminium-Profiltschiene 40mm breit, farblos eloxiert, zum Einklippen in Profiltschiene 40x40mm. Sonderlängen auf Anfrage.

Cover plate, aluminium profile 40mm wide, natural anodized, to clip-in the base profile 40x40mm. Customised lengths on request.

Art. No.		L [mm]
4500-M01		6300
4500-M11		1180
4500-M21		1480

Plaque de fermeture, profilé en aluminium anodisé nature 40mm de large, à encliqueter au profilé 40x40mm. Longueurs spéciales sur demande.



Leuchteneinsatz, Aluminium-Profil farblos eloxiert, werkzeuglos einklippbar in Aluminiumprofiltschiene 40x40mm.

Luminaire, aluminium profile, natural anodized, for a tool-free clip-in the base profile 40x40mm.

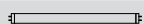
Art. No.		L [mm]
4560-M1287	1x28W T5	1180
4560-M1547	1x54W T5	1180
4560-M1357	1x35W T5	1480
4560-M1807	1x80W T5	1480

Corps de luminaire, profilé en aluminium anodisé nature 40x40mm, à encliqueter au profilé 40x40mm sans outils.

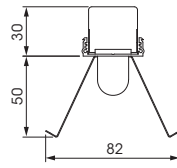

Leuchteneinsatz zur Aufnahme von Spiegelrastern, Aluminium-Profil farblos eloxiert, werkzeuglos ein-
klippbar in Aluminium-Profileschiene 40x40mm, mit
speziellem Primärreflektor zur Verbesserung des
Leuchtenwirkungsgrades [Raster separat bestellen].

Luminaire for louvre, aluminium profile, natural
anodized, for a tool-free clip-in the base profile
40x40mm, equipped with a special primary reflector
to increase the luminous efficiency [louvre to be or-
dered separately].

Art. No.	☰	L [mm]
4562-M1287	1 x 28W T5	1180
4562-M1547	1 x 54W T5	1180
4562-M1357	1 x 35W T5	1480
4562-M1807	1 x 80W T5	1480

Corps de luminaire adapté à l'écran miroité, profilé
en aluminium anodisé nature, à encliqueter au pro-
filé 40x40mm sans outils, équipé d'un réflecteur pri-
maire pour augmenter l'efficacité lumineuse [Ecran
miroité à commander séparément].

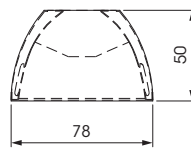
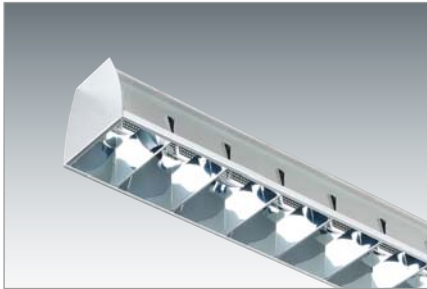

Spiegelraster, hochglanz, direkt/indirekt strahlend,
rundum entblendet, werkzeuglos auf Leuchtenein-
satz aufklippbar.

Mirror louvre, highly polished, direct/indirect illumina-
tion, glare free, tool-free clip-on the luminaire.

Art. No.	☰	L [mm]
4562DI-R79	1 x 28/54W T5	1180
4562DI-R99	1 x 35/80W T5	1480

Ecran en aluminium miroité poli brillant, éclairage
direct/indirect, non-éblouissant de toutes les di-
rections, à encliqueter sans outils au corps de lumi-
naire.

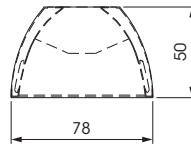
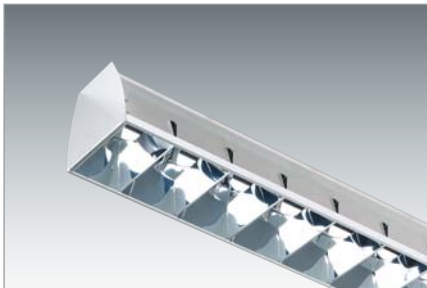

Spiegelraster, hochglanz, direkt strahlend, rundum
entblendet, werkzeuglos auf Leuchteneinsatz auf-
klippbar.

Mirror louvre, highly polished, direct illumination,
glare free, tool-free clip-on the luminaire.

Art. No.	☰	L [mm]
4562DD-R79	1 x 28/54W T5	1180
4562DD-R99	1 x 35/80W T5	1480

Ecran en aluminium miroité poli brillant, éclairage di-
rect, non-éblouissant de toutes les directions, à encli-
queter sans outils au corps de luminaire.



Art. No.	⏏	L [mm]
4561-M1287	1 x 28W T5	1180
4561-M1547	1 x 54W T5	1180
4561-M1357	1 x 35W T5	1480
4561-M1807	1 x 80W T5	1480

Leuchteinsatz zur Aufnahme von Reflektoren, Aluminium-Profil farblos eloxiert, werkzeuglos einklippbar in Aluminium-Profilsschiene 40x40mm, mit Befestigungsschrauben zur Aufnahme von symmetrischen und asymmetrischen Reflektoren [Reflektoren separat bestellen].

Luminaire for reflector, aluminium profile, natural anodized, for a tool-free clip-in the base profile 40x40mm, equipped with fixing screws for symmetrical and asymmetrical reflectors [reflectors to be ordered separately].

Corps de luminaire adapté au réflecteur, profilé en aluminium anodisé nature, à encliqueter au profilé 40x40mm sans outils, avec vis de fixation pour réflecteurs symétriques et asymétriques [réflecteurs à commander séparément].

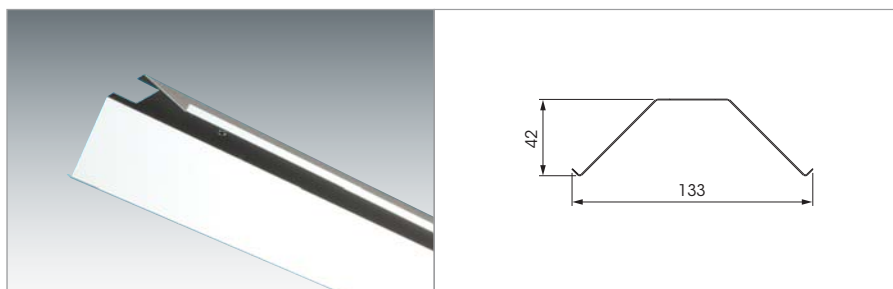

Art. No.	⏏	L [mm]
4561RS-F79	1 x 28/54W T5	1180
4561RS-F99	1 x 35/80W T5	1480

Reflektor, symmetrisch strahlend, Aluminium matt.

Trough reflector, symmetrical illumination, aluminium matt.

Réflecteur à rayonnement symétrique, aluminium mat.

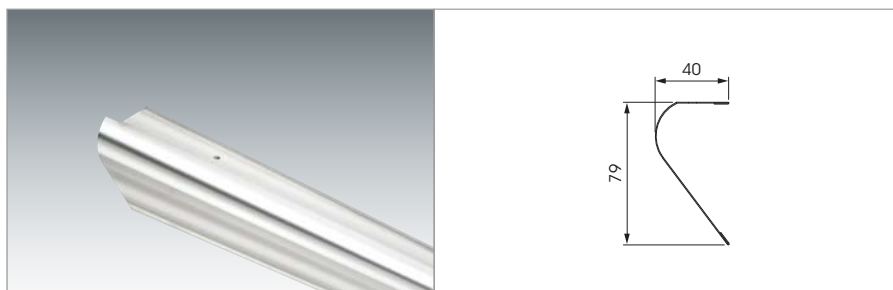

Art. No.	⏏	L [mm]
4561RA-F79	1 x 28/54W T5	1180
4561RA-F99	1 x 35/80W T5	1480

Reflektor, asymmetrisch strahlend, Aluminium matt.

Reflector asymmetrical illumination, aluminium matt.

Réflecteur à rayonnement asymétrique, aluminium mat.

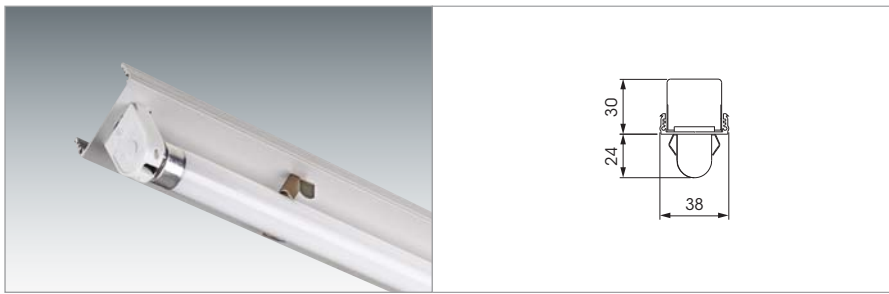

Leuchteinsatz zur Aufnahme von Deco-Acrylglas. Aluminium-Profil farblos eloxiert, werkzeuglos ein-
klippbar in Aluminium-Profilsschiene, mit Befestigungs-
federn zur werkzeuglosen Aufnahme eines Acrylglas-
ses [Acrylglas separat bestellen].

Luminaire for decorative diffuser, aluminium profile,
natural anodized, for a tool-free clip-in the base pro-
file, equipped with special spring clips to fit acrylic
diffuser tool-free [acrylic diffuser to be ordered sep-
arately].

Art. No.	⊖ ⊕	L [mm]
4563-M1287	1 x 28 W T5	1180
4563-M1547	1 x 54 W T5	1180
4563-M1357	1 x 35 W T5	1480
4563-M1807	1 x 80 W T5	1480

Corps de luminaire adapté au verre acrylique, profilé
en aluminium anodisé nature, à encliqueter au pro-
filé sans outils, équipé d'étriers pour fixation d'un
verre acrylique sans outils [verre acrylique à com-
mander séparément].

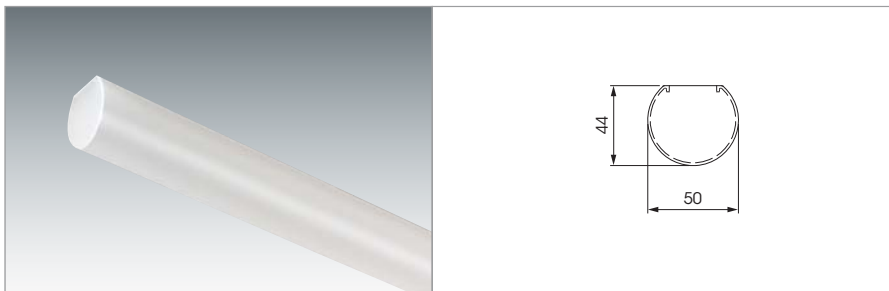

Acrylglas satiné.
Sonderlängen auf Anfrage.

Acrylic diffuser, opal satiné.
Customised lengths on request.

Art. No.	⊖ ⊕	L [mm]
4563GS-G79	1 x 28/54 W T5	1180
4563GS-G99	1 x 35/80 W T5	1480

Verre acrylique satiné.
Longueurs spéciales sur demande.

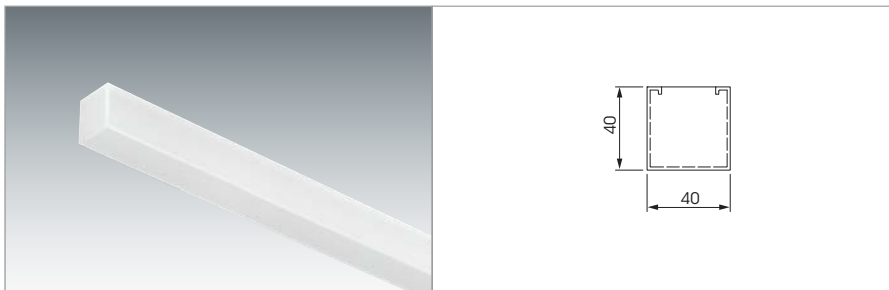

Acrylglas satiné.
Sonderlängen auf Anfrage.

Acrylic diffuser, opal satiné.
Customised lengths on request.

Art. No.	⊖ ⊕	L [mm]
4563GQ-G79	1 x 28/54 W T5	1180
4563GQ-G99	1 x 35/80 W T5	1480

Verre acrylique satiné.
Longueurs spéciales sur demande.

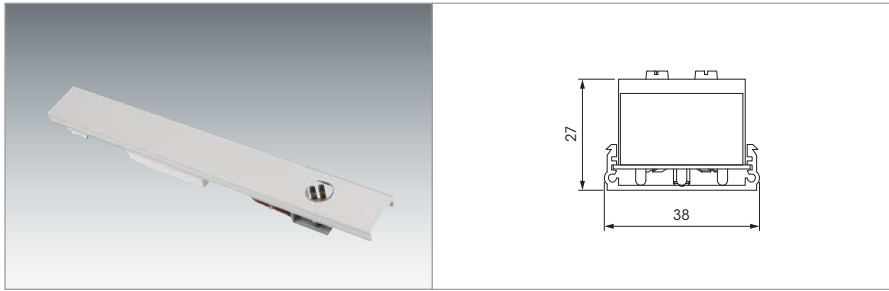

Profilabdeckung, farblos eloxiert, mit integrierter Fassung G9 zur Aufnahme einer Halogen-Lampe 230V, max. 50W, werkzeuglos einklippbar in Aluminium-Profilsschiene 40x40mm.

Cover plate, aluminium profile, natural anodized, with integrated lampholder G9 for halogen lamp 230V, max. 50W, for a tool-free clip-in the base profile 40x40mm.

Plaque de fermeture, profilé en aluminium anodisé nature avec douille intégré G9 pour lampe à halogène 230V, max. 50W, à encliquer au profilé 40x40mm sans outils.

Art. No.	L [mm]
4593	300

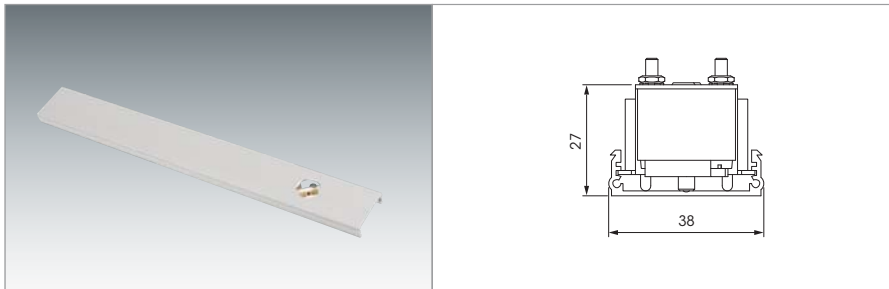

Profilabdeckung, farblos eloxiert mit eingebautem elektronischem Trafo 60VA und integrierter Fassung GY6,35 zur Aufnahme einer Halogen-Niedervoll Lampe max. 50W, werkzeuglos einklippbar in Aluminium-Profilsschiene 40x40mm.

Cover plate, aluminium profile, natural anodized, with built-in transformer 60VA and integrated lampholder GY6,35 for halogen low voltage lamps max. 50W, for a tool-free clip-in the base profile 40x40mm.

Plaque de fermeture, profilé en aluminium anodisé nature avec transformateur 60VA et douille intégré GY6,35 pour lampe à halogène bas voltage max. 50W, à encliquer au profilé 40x40mm sans outils.

Art. No.	L [mm]
4592	300

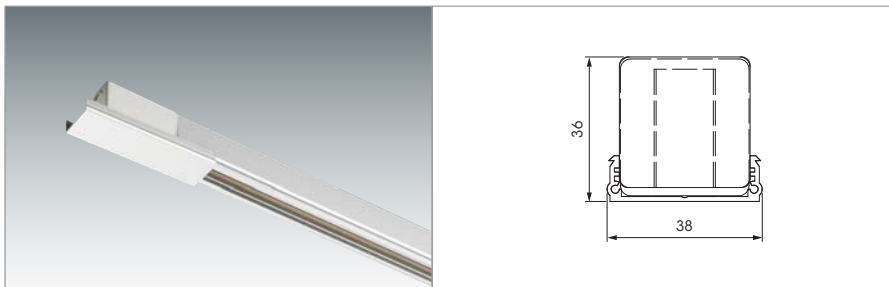

Profilabdeckung mit eingebauter 3-Phasen-Stromschiene 230V, werkzeuglos einklippbar in Aluminium-Profilsschiene 40x40mm.

Profile cover plate with built-in 3-phase rail-conductor, for a tool-free clip-in the base profile 40x40mm.

Plaque de fermeture avec rail-conducteur triphasé intégré, à encliquer au profilé 40x40mm sans outils.

Art. No.		L [mm]
4596	Mittelteil mit Einspeisung links und rechts	1180
	Middle piece with rail-conductor left and right	
	Pièce intermédiaire avec alimentations à gauche et à droite	
4597	Endstück mit Einspeisung	1180
	End piece with rail-conductor	
	Embout avec alimentation	

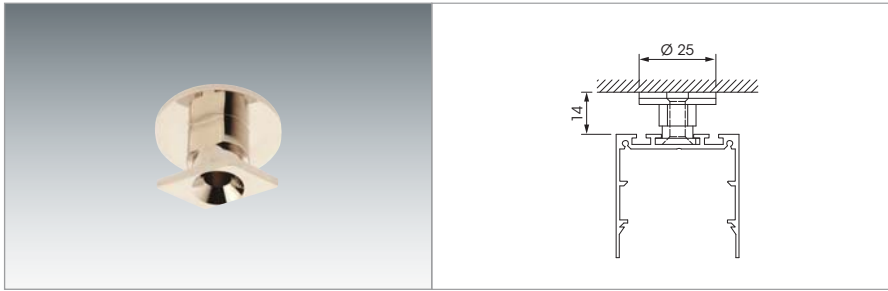

Befestigungsflansch für die Montage der Leuchten an die Decke mit einem Abstand von 14mm [pro Leuchte 2 Stück bestellen].

Flange fitting for ceiling mounting at a distance of 14mm [2 pieces per luminaire].

Art. No.
4512

Bride de fixation pour le montage au plafond avec un écart de 14mm [à commander 2 pièces par luminaire].

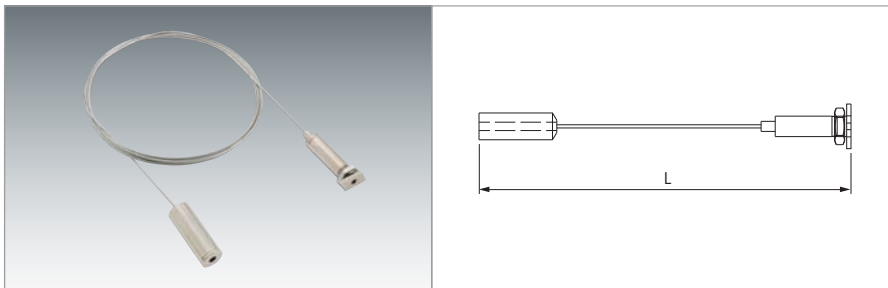

Stahlseilabhangung.

Bestellmenge:

- 2 Stück für 1-längige Leuchten.
- mind. 2 Stück für 2-längige Leuchten.
- mind. 3 Stück für 3-längige Leuchten.

Suspension wire.

Order quantities:

- 2 units for single-length luminaires.
- minimum of 2 units for double-length luminaires.
- minimum of 3 units for triple-length luminaires.

Art. No.	L [mm]
4511	max. 2000

Suspension à câble d'acier.

Quantités à commander:

- 2 pièces pour luminaires mono.
- minimum 2 pièces pour luminaires duo.
- minimum 3 pièces pour luminaires triple.

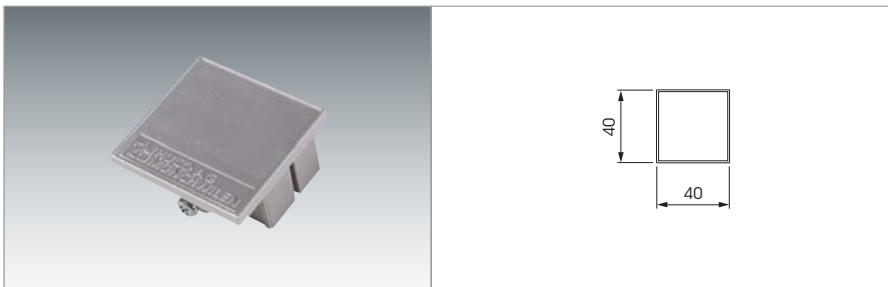

Stirnseite, Kunststoff RAL 9006 [pro Leuchte 2 Stück bestellen].

End cap, plastic RAL 9006 [2 pieces per luminaire].

Art. No.
4500-S19

Plaque frontale, plastique RAL 9006 [à commander 2 pièces par luminaire].

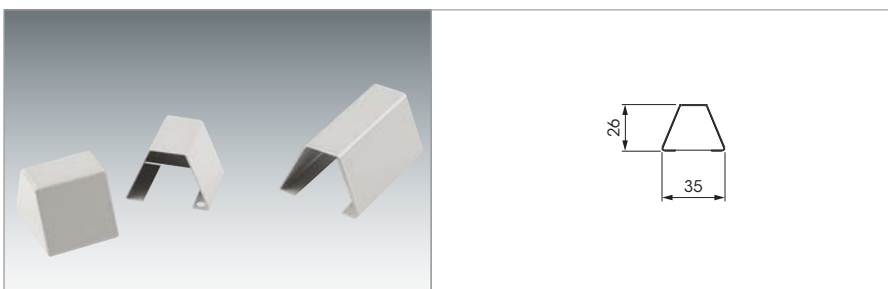

Fassungskaschierung, RAL 9006 thermolackiert, einseitig geschlossen [pro Leuchte 2 Stück bestellen].

Doppel-Fassungskaschierung, RAL 9006 thermolackiert [pro Leuchte 1 Stück bestellen].

Lampholder box, colour RAL 9006, one side open [2 pieces per luminaire].

Double lampholder box, colour RAL 9006, [1 piece per luminaire].

Art. No.	L [mm]
Fassungskaschierung	
Lampholder box	
Cache-douille	
4500-C69	28
Doppel-Fassungskaschierung	
Double lampholder box	
Cache-douille double	
4500-C79	56

Cache-douille, RAL 9006 thermolackiert, fermé d'un côté [à commander 2 pièces par luminaire].

Cache-douille double, RAL 9006 thermolackiert [à commander 1 pièce par luminaire].

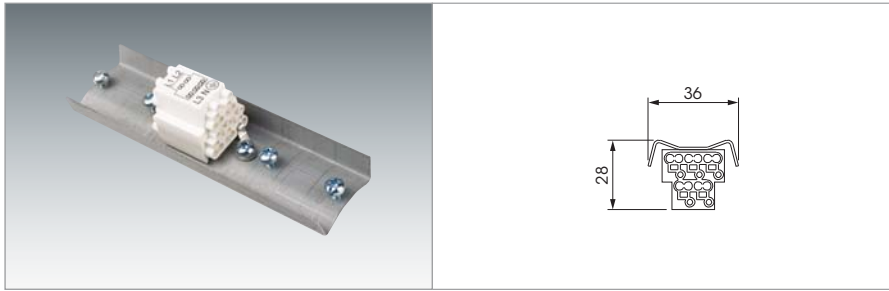

Art. No.

4590

Profilverbinder mit Klemme 5x1,5mm².

Rail connector with terminal 5x1.5mm².

Eclisse de liaison avec borne 5x1,5mm².

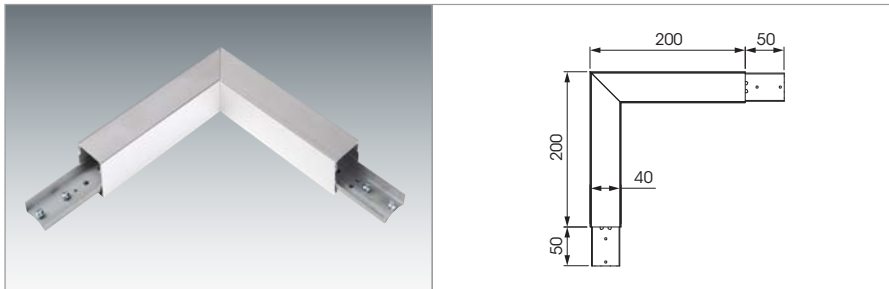

Art. No.

4591

Eckverbinder, Aluminium-Profil farblos eloxiert.

Angle connector, aluminium profile, natural anodized.

Raccord d'angle, profilé en aluminium anodisé nature.

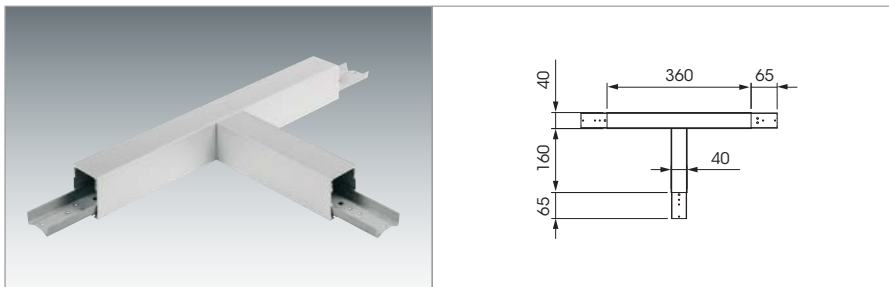

Art. No.

4594

T-Verbinder, Aluminium-Profil farblos eloxiert.

T-connector, aluminium profile, natural anodized.

Raccord en T, profilé en aluminium anodisé nature.

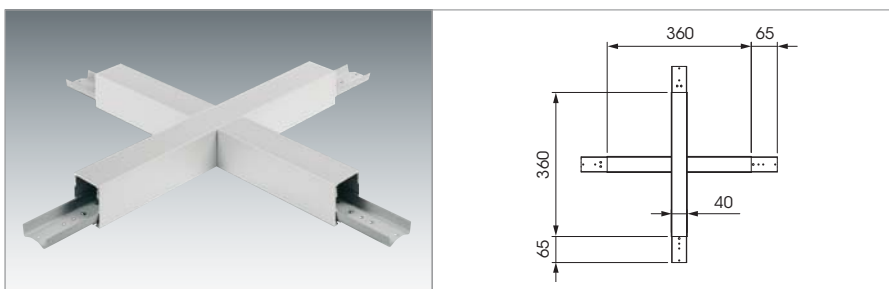

Art. No.

4595

Kreuz-Verbinder, Aluminium-Profil farblos eloxiert.

Cross-connector, aluminium profile, natural anodized.

Raccord en croix, profilé en aluminium anodisé nature.